

Service Guide

# IntelliVue Patient Monitor MP5/MP5T

Patient Monitoring

Part Number M8105-9301C  
453564112551



**PHILIPS**

# Table of Contents

|   |           |
|---|-----------|
| <b>1 Introduction</b>                               | <b>9</b>  |
| Who Should Use This Guide                           | 9         |
| How to Use This Guide                               | 9         |
| Abbreviations                                       | 9         |
| Responsibility of the Manufacturer                  | 10        |
| Passwords   | 10        |
| Warnings and Cautions                               | 11        |
| <b>2 Theory of Operation</b>                        | <b>13</b> |
| Monitor Theory of Operation                         | 13        |
| System Boundaries                                   | 14        |
| Hardware Building Blocks                            | 16        |
| Data Flow   | 19        |
| How does the Support Tool Work with the Monitor     | 22        |
| Monitor Software Block Diagram                      | 23        |
| Block Diagram Legend                                | 24        |
| <b>3 Testing and Maintenance</b>                    | <b>31</b> |
| Introduction  | 31        |
| Terminology and Definitions                         | 32        |
| Recommended Frequency                               | 33        |
| When to Perform Tests                               | 34        |
| Testing Sequence                                    | 37        |
| Visual Inspection                                   | 38        |
| Before Each Use                                     | 38        |
| After Each Service, Maintenance or Repair Event     | 38        |
| Power On Test                                       | 38        |
| Safety Tests  | 39        |
| Warnings, Cautions, and Safety Precautions          | 40        |
| Safety Test Procedures                              | 41        |
| System Test   | 65        |
| What is a Medical Electrical System?                | 65        |
| General Requirements for a System                   | 66        |
| System Example                                      | 66        |
| System Installation Requirements                    | 68        |
| Required Protective Measures at System Installation | 69        |
| System Test Procedure                               | 79        |
| Preventive Maintenance Procedures                   | 80        |
| Noninvasive Blood Pressure Measurement Calibration  | 80        |
| Performance Assurance Tests                         | 80        |

|   |     |
|---|-----|
| Basic Performance Assurance Test  | 80  |
| Full Performance Assurance Test   | 81  |
| ECG/Resp Performance Test   | 81  |
| ECG Sync Performance Test   | 82  |
| SpO2 Performance Test   | 82  |
| NBP Performance Test  | 83  |
| Invasive Pressure Performance Test  | 85  |
| Temperature Performance Test  | 86  |
| Mainstream CO2 Accuracy Check   | 86  |
| Sidestream CO2 Accuracy Check   | 87  |
| Sidestream CO2 Flow Check   | 88  |
| Microstream CO2 Performance Test  | 89  |
| Nurse Call Relay Performance Test   | 94  |
| Power Loss Alarm Buzzer Performance Test (only if Multi-Port Nurse Call Connector Board is installed) | 96  |
| IntelliVue 802.11 Bedside Adapter Communication Test  | 96  |
| IIT Communication Test  | 97  |
| Short Range Radio (SRR) Performance Test  | 98  |
| Reporting of Test Results   | 99  |
| Carrying Out and Reporting Tests  | 99  |
| Evaluation of Test Results  | 102 |
| Other Regular Tests   | 103 |
| Touchscreen Calibration   | 103 |
| Disabling/Enabling Touch Operation  | 104 |
| Printer Test Report   | 104 |
| Battery Handling, Maintenance and Good Practices  | 105 |
| About the Battery   | 105 |
| Checking the Battery Status   | 106 |
| Battery Status on the Main Screen   | 107 |
| Battery Status Window   | 108 |
| Conditioning a Battery  | 109 |
| Conditioning Batteries  | 111 |
| After Installation, Testing or Repair   | 112 |

## **4 Troubleshooting** **115**

---

|   |     |
|---|-----|
| Introduction  | 115 |
| How To Use This Section   | 115 |
| Who Should Perform Repairs  | 115 |
| Replacement Level Supported   | 116 |
| Software Revision Check   | 116 |
| Compatibility of MP5 in Companion Mode with IntelliVue Patient Monitors | 116 |
| Compatibility with Information Center                                   | 117 |
| Obtaining Replacement Parts   | 117 |
| Troubleshooting Guide   | 117 |
| Checks for Obvious Problems   | 117 |

|   |     |
|---|-----|
| Checks Before Opening the Instrument                        | 118 |
| Troubleshooting Tables                                      | 120 |
| Status Log  | 143 |
| List of Error Codes   | 144 |
| Troubleshooting with the Support Tool                       | 145 |
| Troubleshooting the Individual Measurements or Applications | 145 |

## **5 Repair and Disassembly** **147**

---

|  |     |
|--|-----|
| Who Should Perform Repairs   | 147 |
| Tools required   | 148 |
| Removing the Handle or Bedhanger   | 149 |
| Removing the Predictive Temperature Assembly   | 150 |
| Disassembling the Predictive Temperature Assembly                                    | 152 |
| Separating the Front and Back of the Monitor   | 153 |
| Removing the Recorder Slot Cover   | 158 |
| Removing the Internal Quick Mount Solution   | 159 |
| Removing the Short Range Radio (SRR) Interface                                       | 159 |
| Removing the IntelliVue 802.11 Bedside Adapter Antenna or IIT Antenna (not for MP5T) | 162 |
| Removing the IntelliVue 802.11 Bedside Adapter (WLAN) (not for MP5T)                 | 162 |
| Removing the IntelliVue Instrument Telemetry (IIT) Module (not for MP5T)             | 166 |
| Removing the IntelliVue 802.11 Bedside Adapter/IIT Holder (not for MP5T)             | 167 |
| Removing the MSL Board (not for MP5T)  | 168 |
| Removing the Backlight Inverter Board  | 169 |
| Removing the Power Supply  | 171 |
| Removing the System Interface Board  | 173 |
| Removing the Recorder Board  | 174 |
| Removing the Microstream CO2 Assembly  | 176 |
| Removing the Measurement Block   | 182 |
| Removing the NBP Pump  | 186 |
| Removing the Main Board  | 189 |
| Removing the Touch Assembly  | 192 |
| Removing the Loudspeaker   | 193 |
| Removing the Power Button and LED Assembly   | 194 |
| Removing the LCD Panel   | 196 |
| Exchanging the Backlight   | 197 |
| Modifying the Nurse Call Relay   | 199 |
| Verification Procedure   | 200 |

## **6 Parts** **201**

---

|  |     |
|--|-----|
| MP5/MP5T Parts                                     | 202 |
| Exchange and Replacement Parts                     | 202 |
| 5/6 Lead vs. 12 Lead ECG Capability Identification | 211 |
| External Display Part Numbers (not for MP5T)       | 214 |

|  |     |
|--|-----|
| Out-Of-Hospital Transport - Standards Compliance                             | 216 |
| Electromagnetic Emissions  | 217 |
| Electromagnetic Interference (SRR)   | 218 |
| Installation Checklist   | 218 |
| Unpacking and Checking the Shipment  | 219 |
| Initial Inspection   | 219 |
| Claims For Damage and Repackaging  | 220 |
| Installing the Predictive Temperature Probe                                  | 220 |
| Mounting the Monitor   | 221 |
| Mounting the Monitor using the Quick Mount                                   | 223 |
| Mounting the Monitor using the Mounting Plate (Fix Mount)                    | 224 |
| Connecting the Monitor to AC Mains   | 226 |
| Checking Out The Monitor   | 227 |
| Connections  | 227 |
| Connection of Devices via the MIB/RS232 Interface                            | 228 |
| Loading Paper  | 229 |
| Configuration Tasks  | 229 |
| Checking Country-Specific Default Settings                                   | 230 |
| Setting Altitude, Line Frequency, ECG Cable Colors and Height & Weight Units | 230 |
| Configuring the Equipment Label  | 231 |
| Configuring IP Address, Subnet Mask and Default Gateway                      | 231 |
| Configuration Settings for CSCN Routed Bedside Monitors (RBM)                | 232 |
| Configuring Routed Bedside Monitors Support                                  | 232 |
| Setting the Date and Time  | 233 |
| Handing Over the Monitor   | 233 |
| Installing Remote Devices (not for MP5T)                                     | 233 |
| Mounting the 15" Remote Display (M8031B)                                     | 233 |
| Mounting the 17" Remote Display (M8033C)                                     | 234 |
| Hardware Settings  | 235 |
| Philips Clinical Network (Wired) (not for MP5T)                              | 235 |
| Philips Clinical Network (Wireless) (not for MP5T)                           | 236 |
| Philips IntelliVue Information Center  | 236 |
| IntelliVue Instrument Telemetry (IIT)(not for MP5T)                          | 237 |
| Short Range Radio  | 238 |
| Configuring SRR Channels   | 238 |
| Connecting the MP5 to a Host Monitor (not for MP5T)                          | 241 |
| Nurse Call Relay (not for MP5T)  | 242 |
| Connections  | 242 |
| ECG Out Functionality (ECG Sync) (not for MP5T)                              | 242 |
| Connections  | 242 |
| ECG Sync Pulse (not for MP5T)  | 243 |



|  |            |
|--|------------|
| <b>8 Site Preparation</b>                                | <b>245</b> |
| Introduction   | 245        |
| Site Planning  | 245        |
| Roles & Responsibilities                                 | 246        |
| Monitor Site Requirements                                | 248        |
| Space Requirements                                       | 248        |
| Environmental Requirements                               | 248        |
| Electrical and Safety Requirements (Customer or Philips) | 249        |
| Remote Device Site Requirements                          | 250        |
| Connecting Non-Medical Devices                           | 251        |
| Remote Displays - M8031B                                 | 251        |
| Remote Displays - M8033C                                 | 252        |
| Philips Medical LAN                                      | 254        |
| RS232/MIB Interface                                      | 254        |
| Telemetry Device (Patient Worn Device) cables            | 255        |
| Nurse Call Relay Interface                               | 256        |
| ECG Out Interface  | 256        |
| <b>9 Gas Analyzers (not for MP5T)</b>                    | <b>257</b> |
| <b>10 MP5 Product Structure</b>                          | <b>260</b> |
| Upgrades   | 265        |
| <b>11 Default Settings Appendix</b>                      | <b>267</b> |
| Country-Specific Default Settings                        | 267        |
| <b>12 Index</b>  | <b>277</b> |





---

# Introduction

This Service Guide contains technical details for the IntelliVue MP5/MP5T Patient Monitor

This guide provides a technical foundation to support effective troubleshooting and repair. It is not a comprehensive, in-depth explanation of the product architecture or technical implementation. It offers enough information on the functions and operations of the monitoring system so that engineers who repair them are better able to understand how it works.

## Who Should Use This Guide

This guide is for biomedical engineers or technicians responsible for installing, troubleshooting, repairing, and maintaining Philips' patient monitoring systems.

## How to Use This Guide

This guide is divided into eight sections. Navigate through the table of contents at the left of the screen to select the desired topic. Links to other relevant sections are also provided within the individual topics. In addition, scrolling through the topics with the page up and page down keys is also possible.

## Abbreviations

Abbreviations used throughout this guide are:

| <b>Name</b>                         | <b>Abbreviation</b> |
|-------------------------------------|---------------------|
| IntelliVue MP5/MP5T Patient Monitor | the monitor         |
| Medical Information Bus             | MIB                 |

# Responsibility of the Manufacturer

Philips only considers itself responsible for any effects on safety, EMC, reliability and performance of the equipment if:

- assembly operations, extensions, re-adjustments, modifications or repairs are carried out by persons authorized by Philips, and
- the electrical installation of the relevant room complies with national standards, and
- the instrument is used in accordance with the instructions for use.

To ensure safety and EMC, use only those Philips parts and accessories specified for use with the monitor. If non-Philips parts are used, Philips is not liable for any damage that these parts may cause to the equipment.

This document contains proprietary information which is protected by copyright. All Rights Reserved. Reproduction, adaptation, or translation without prior written permission is prohibited, except as allowed under the copyright laws.

Philips Medizin Systeme Böblingen GmbH

Hewlett-Packard Str. 2

71034 Böblingen, Germany

The information contained in this document is subject to change without notice.

Philips makes no warranty of any kind with regard to this material, including, but not limited to, the implied warranties or merchantability and fitness for a particular purpose.

Philips shall not be liable for errors contained herein or for incidental or consequential damages in connection with the furnishing, performance, or use of this material.

## Passwords

In order to access different modes within the monitor a password may be required. The passwords are listed below.

Monitoring Mode: No password required

Configuration Mode: 71034

Demo Mode: 14432

Service Mode: 1345

Consult the configuration guide before making any changes to the monitor configuration.

# Warnings and Cautions

In this guide:

- A **warning** alerts you to a potential serious outcome, adverse event or safety hazard. Failure to observe a warning may result in death or serious injury to the user or patient.
- A **caution** alerts you where special care is necessary for the safe and effective use of the product. Failure to observe a caution may result in minor or moderate personal injury or damage to the product or other property, and possibly in a remote risk of more serious injury.



# Theory of Operation

## Monitor Theory of Operation

The IntelliVue MP5/MP5T Patient Monitor:

- displays real-time data
- alarms in the case of patient or equipment problems
- offers limited data storage and retrieval (trending)
- interfaces to the Philips Clinical Network and other equipment (not MP5T)

The monitor can be configured with various different measurement and interface capabilities.

The following comparison table shows in detail the differences between MP5 and MP5T:

| Functionality (including optional features)           | MP5 | MP5T |
|---|-----|------|
| ECG   | yes | no   |
| SpO2  | yes | yes  |
| NBP   | yes | yes  |
| Predictive Temperature                                | yes | yes  |
| Temperature   | yes | no   |
| Invasive Pressure                                     | yes | no   |
| Carbon Dioxide  | yes | no   |
| Microstream CO <sub>2</sub>                           | yes | no   |
| Direct Telemetry Connection                           | yes | yes  |
| ECG Output signal                                     | yes | no   |
| LAN networking capability                             | yes | no   |
| WLAN networking capability                            | yes | no   |
| IntelliVue Instrument Telemetry networking capability | yes | no   |

| Functionality (including optional features)   | MP5 | MP5T |
|---|-----|------|
| Short Range Radio capability                  | yes | yes  |
| Severe Sepsis Screening                       | yes | no   |
| OxyCRG high resolution trend                  | yes | no   |
| Neonatal event review                         | yes | no   |
| Integrated recorder                           | yes | yes  |
| Drug Calculator                               | yes | yes  |
| Gas monitor support                           | yes | no   |
| Connection to a host monitor (companion mode) | yes | no   |
| Connection to an external display             | yes | no   |
| Nurse call capability                         | yes | no   |

**NOTE**



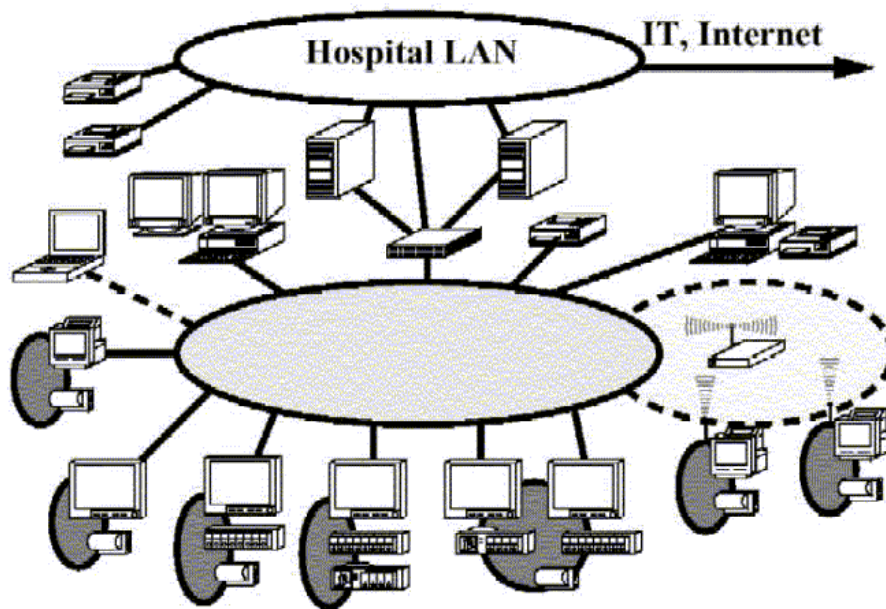

The following descriptions may vary depending on the monitor option purchased.

**System Boundaries**

The following diagram discusses specific boundaries within the overall system with respect to their openness and real-time requirements:

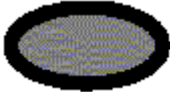

**System Boundaries**

|   |   |
|---|---|
|  | Measurement connections<br>Built-in measurement block   |
|  | Philips Clinical Network (wired LAN)<br>connects multiple patient monitors, information centers, application servers; closed system, only Philips qualified products (tested and with regulatory approval) are connected, Philips is responsible for guaranteed real-time functionality and performance |
|  | Philips Clinical Network (wireless)<br>like Philips Clinical Network (wired) LAN, however due to current wireless technologies available it has reduced bandwidth, longer latencies, reduced functionality  |
|  | Hospital LAN, Internet<br>Standard Network, not under Philips control, no guaranteed service, no real-time requirements   |

### Hardware Building Blocks

The following hardware building blocks make up the monitoring system. (Note that the MP5T does not include all the hardware components shown below):

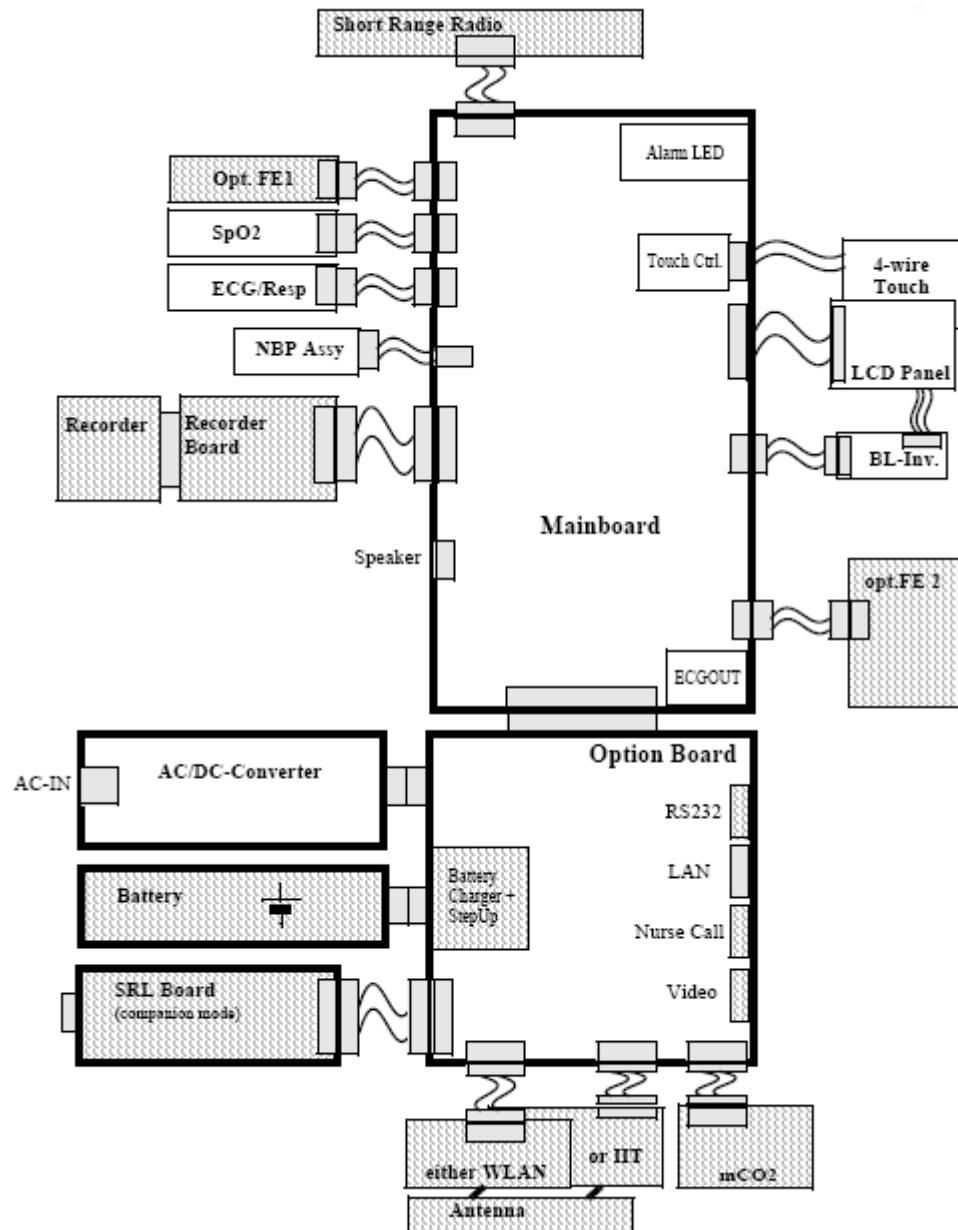

**MP5 Hardware Building Blocks**



## IntelliVue MP5/MP5T

The MP5/MP5T monitor:

- integrates the display and processing unit into a single package
- uses a 8.4" TFT SVGA color display
- uses the Touchscreen as input device
- integrates the measurement block (Front End 1 (FE1) and Front End 2 (FE2)) with optional parameter sets

## Optional Hardware

- One slot is provided for one of three available system interface boards. An optional built-in wireless network interface IntelliVue 802.11 Bedside Adapter or IntelliVue Instrument Telemetry) is supported. For further details regarding the wireless network please refer to the M3185A Philips Clinical Network documentation.
- optional recorder
- optional battery
- optional MSL board
- optional Short Range Radio (SRR) board

## Power Distribution

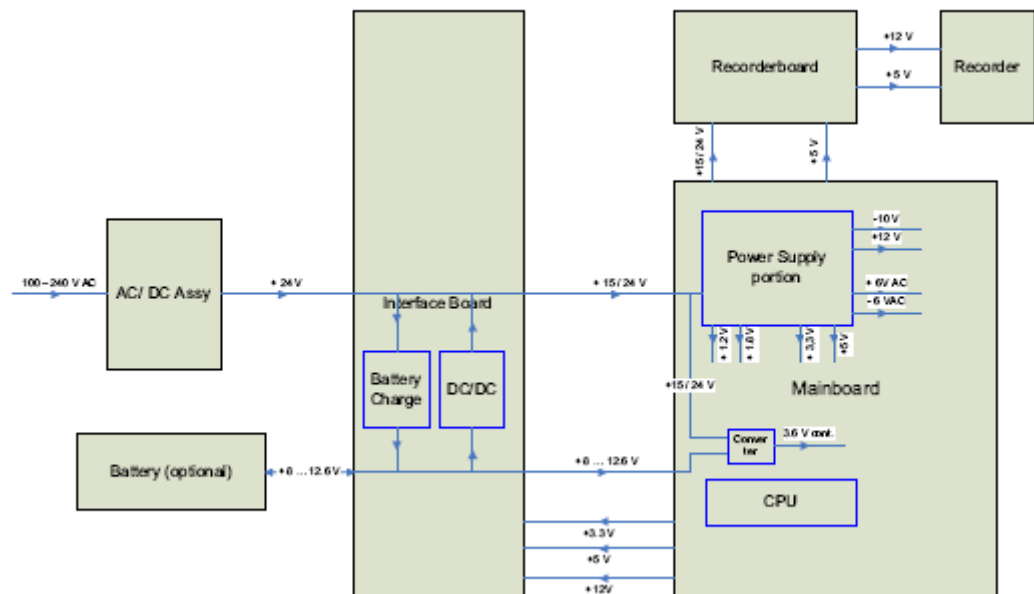

**Power Distribution Architecture**

The AC/DC converter transforms the AC power (100-240 V AC range) coming from the power plug into a 24 V / 50W DC source and isolates the monitoring system from the AC power mains.

The 24 V DC is distributed via the Interface Board to the optional battery charging circuit and to the main- and recorder board.

If the interface board contains the optional battery circuits, the power is used to charge the battery and supply the monitoring system. As soon as the AC power source is disconnected, the optional battery starts and keeps the system powered (battery mode). A DC/DC converter on the interface board converts the 8-12.6 V DC power supplied by the battery into 15 V DC power, which is distributed to the monitoring system.

The main board and recorder board contain power supply circuits, which convert the 24 /15 V DC into several voltages supplying the particular components of the monitoring system.

The realtime clock and the buffered RAM is supplied with cont. 3.6 V DC power, provided either by the 24 / 15 V DC system power or by the battery power and converted to 3.6 V DC.

The CPU board has an MPC852/62 MHz processor in the patient monitor that provides a number of on-chip, configurable interfaces. An array of fast UARTS with configurable protocol options are implemented in an ASIC (along with other system functions such as independent watchdogs, video, etc.), providing interfacing capabilities to integrated measurements and System Interface Boards. The serial interfaces can easily be electrically isolated. The main board contains additional video hardware.

The CPUs provide a LAN interface to connect to the Philips Clinical Network (Ethernet).

#### NOTE

An MP5 in companion mode does not receive its power from the host monitor via the MSL. MP5 is always powered by AC power or battery.

### System Interfaces

The following is a list of Interface boards which may be present in your monitor, depending on your purchased configuration:

System Interface boards:

- Basic: LAN, Video #J01(no longer orderable)
- Battery: LAN, Battery Board, mCO<sub>2</sub> #J02
- Full: LAN, Battery, MIB/RS232, Video, Nurse Call, mCO<sub>2</sub> #J40

Note that WLAN, IIT and MSL Interface require the full system interface board.

The MP5T is delivered only with the battery system interface board.

The specifications for the above listed interfaces can be found in the technical data sheet for the monitor and in the *Installation and Specifications* chapter of the Instructions for Use.

## Compatible Devices



**IntelliVue G1/G5 Anesthetic Gas Module**

## Data Flow

The following diagram shows how data is passed through the monitoring system. The individual stages of data flow are explained below.

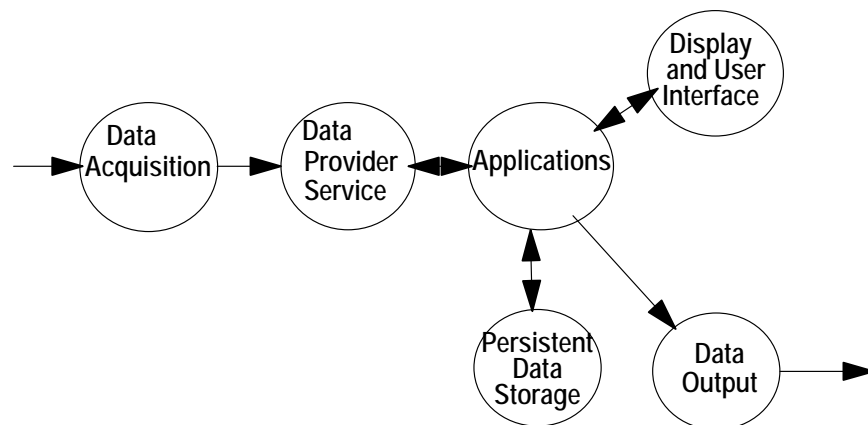

### Data Flow

#### Data Acquisition

Monitoring data (for example patient measurement data in the form of waves, numerics and alerts) is acquired from a variety of sources:

- Measurement Block

The integrated measurements convert patient signals to digital data and apply measurement algorithms to analyze the signals.

- External measurement devices

Data can be also acquired from devices connected to interface boards of the monitor. Software modules dedicated to such specific devices convert the data received from an external device to the format used internally. This applies to the IntelliVue G1/G5 Anesthetic Gas Module.

- Server systems on the Philips Clinical Network

To enable networked applications such as the other bed overview, data can be acquired from server systems attached to the Philips Clinical Network, for example a Philips Information Center

### **Data Provider System Service**

All data that is acquired from integrated measurements or external measurement devices is temporarily stored by a dedicated data provider system service. All monitor applications use this central service to access the data in a consistent and synchronized way rather than talking to the interfaces directly.

This service makes the applications independent of the actual type of data acquisition device.

The amount of data stored in the data provider system service varies for the different data types. For example several seconds of wave forms and the full set of current numerical values are temporarily stored in RAM.

### **Persistent Data Storage System Service**

Some applications require storage of data over longer periods of time. They can use the persistent data storage system service. Dependent on the application requirements, this service can store data either in battery backed-up (buffered) memory or in flash memory. The buffered memory will lose its contents if the monitor is without power (not connected to mains) for an extended period of time. The flash memory does not lose its contents.

The trend application for example stores vital signs data in a combination of flash memory and buffered memory, while the system configuration information (profiles) is kept purely in flash memory.

### **Display and User Interface Service**

Applications can use high level commands to display monitoring data or status and command windows on the internal LCD panel. These commands are interpreted by the display manager application. This application controls the dedicated video hardware which includes video memory and a special hardware in the ASIC.

User input is acquired from the touchscreen. The system software makes sure that the user input is directed to the application which has the operating focus.

## Monitor Applications

The monitor applications provide additional system functionality over the basic measurement and monitoring capabilities. This includes for example trending, report generating, event storage or derived measurements.

In general, the monitor applications use the data provider system service to access the measurement data. Application interfaces to the other system services allow the application to visualize data, to store data over extended periods of time or to output data to other devices.

## Internal LAN (Measurement Link)

The MP5/MP5T communicates as a Multi-Measurement Module (MMS) in companion mode when connected to a host monitor using an IEEE802.3/Ethernet LAN in the Measurement Link (MSL). This network is used to distribute data between the the MP5/MP5T and the host monitor, for example:

- Digitized patient signals including wave data, numerical data and status information (typically from the measurement server to a display unit)
- Control data representing user interactions (typically from the display unit to a measurement server)
- Shared data structures, for example representing patient demographical data and global configuration items

The internal LAN allows plug and play configuration of the monitoring system. The system automatically detects plugging or unplugging of measurement servers on the host monitor and configures the system accordingly.

The components on the internal LAN are time-synchronized to keep signal data consistent in the system. Dedicated hardware support for synchronization eliminates any latency of the network driver software.

The integrated LAN provides deterministic bandwidth allocation/reservation mechanisms so that the real-time characteristic of signal data and control data exchange is guaranteed. This applies to the data flow from the measurement server to the monitor (for example measurement signal data) and the data flow from the monitor to a measurement server (for example to feed data to a recorder module).

Integrated communication hubs in the monitor allow flexible cabling options (star topology, daisy chaining of servers).

### NOTE

The MP5/MP5T does not support any MMS on the MSL.

## Philips Clinical Network

The monitoring system may be connected to the Philips Clinical Network, for example to provide central monitoring capabilities or other network services. This connection may be through a normal wired connection or through a wireless connection.

The monitor supports the connection of an internal wireless adapter (#J35, #J45, #J47). Switching between wired and wireless networks is automatically triggered by the plugging or unplugging of the network cable.

After configuration, the monitoring system sends the digitized patient signals including wave data, numerical data and status information onto the network. Control data representing user interactions can be exchanged between the monitoring system and a central station bi-directionally.

Additional protocols are supported for networked applications, for example for the other bed overview function, which allows viewing of monitoring data from other patients on the network.

For plug and play operation, the monitoring system uses the standard BootP protocol to automatically acquire a network address.

## How does the Support Tool Work with the Monitor

The support tool is a Windows application typically installed on the laptop of a customer engineer or a biomedical engineer working in the customer's own service department.

The purpose of the support tool is to upgrade, configure and diagnose all monitoring components in the system over the network.

The service protocol developed for this purpose uses a raw access to the devices without the need for IP addresses etc. over a standard customer network installation, so that even defective devices can be upgraded as long as the few kBytes of initial boot code are working. The boot code itself can also be upgraded using the same protocol.

The tool allows access to internal service information and to serial numbers. It can be remote-controlled, for example via a dial-up connection from a response center, provided the proper infrastructure is in place.

For details see the Instructions for Use for the Support Tool.

### Monitor Software Block Diagram

The following shows the functional block diagram for the monitoring system. A legend explaining terms and diagram elements follows. The information below varies depending on the purchased monitor options.

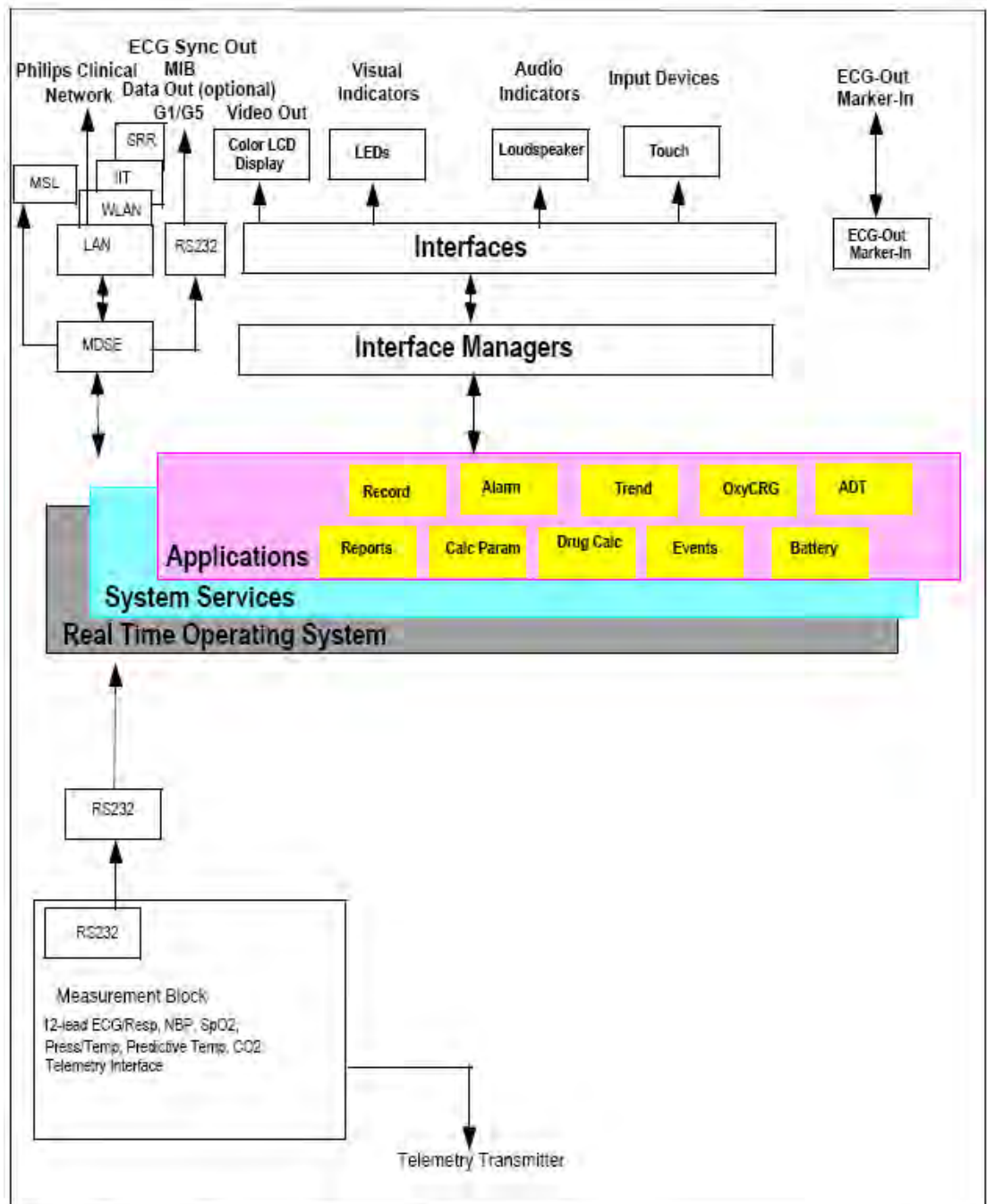

**IntelliVue Patient Monitoring System Functional Block Diagram**

## Block Diagram Legend

| Functional Block | Description  |
|------------------|--|
| Services         |  |
| Operating System | <p>The Operating System (OS) provides a layer of isolation between the specific hardware implementation and the application software. The OS performs system checks and allocates resources to ensure safe operation when the system is first started. This includes internal self-tests on several hardware modules and configuration checks for validity of configuration with the operating software. During normal operation, the OS continues to run checks on system integrity. If error conditions are detected the OS will halt monitoring operations and inform the operator about the error condition.</p> |
| System Services  | <p>The System Services provide generic common system services.</p> <p>In particular:</p> <p>They use a real-time clock component to track time. They synchronize to network time sources and verify the accuracy of the system time information. They are also responsible for managing persistent user configuration data for all Measurement parameters and IntelliVue Patient Monitoring System software modules. User configuration data is stored in a non-volatile read/write storage device</p>   |
| Applications     |  |
| Reports          | <p>The Reports Service retrieves current and stored physiological data and status data to format reports for printing paper documentation. Examples of supported reports:</p> <ul style="list-style-type: none"> <li>- Vital Signs Report</li> <li>- Graphical Trend Report</li> <li>- Event Review Report</li> <li>- Event Episode Report</li> <li>- ECG Report (12 Lead/Multi-Lead)</li> <li>- Test Report</li> </ul> <p>The Reports service generates report data which can be printed on a central printer.</p>  |



| Functional Block | Description  |
|------------------|--|
| Record           | The Record Service retrieves current and stored physiological data and status data to format a continuous strip recording. A recording can be triggered manually by the operator or automatically by an alarm condition. The Record Service uses the services of the Recorder Interface to control a recorder. The Record Service can also send data to a central recorder.  |
| Alarm            | The Alarm Service contains logic that prioritizes alarm conditions that are generated by IntelliVue Patient Monitoring System software modules. Visual alarm signals (messages) are displayed at the top of the IntelliVue Patient Monitoring System display and alarm sounds are generated by a loudspeaker. Alarm conditions may be generated when a physiological parameter exceeds preselected alarm limits or when a physiological parameter or any other software module reports an inoperative status (technical alarm, for example, the ECG leads may have fallen off the patient). The Alarm service manages the alarm inactivation states, for example suspension of alarms, silencing of alarms, and alarm reminder. Alarm signals may also be configured as latching (alarm signals are issued until they are acknowledged by the operator, even when the alarm condition is no longer true). The Alarm service controls the visual alarm signals (alarm lamps). |
| Trend            | The Trend service stores the sample values of physiological data and status data with a resolution of 12 seconds, 1 minute or 5 minutes for a period of up to 48 hours. The data is kept in battery buffered read/write storage and flash memory devices to be preserved across power failures. The stored data is protected via consistency checks and checksums. When a new patient is admitted, the trend database erases all data of the previous patient.   |
| OxyCRG           | The OxyCRG (Oxygen CardioRespiroGram) service derives a high-resolution trend graph from the Beat-to-Beat Heart Rate, SpO <sub>2</sub> , and Respiration physiological data. The OxyCRG is specialized for neonatal applications, allowing the operator to identify sudden drops in Heart Rate (Bradycardia) and SpO <sub>2</sub> (Desaturation), and supporting the operator in visualizing Apnea situations.   |
| ADT              | The ADT (Admit/Discharge/Transmit) service maintains the patient demographics information. The operator may admit a new patient, discharge the old patient and enter or modify the patient demographics.   |

| Functional Block             | Description  |
|------------------------------|--|
| Calc Param                   | The Calc Param (Calculated Parameters) application performs calculations on physiological numerical values to derive calculated parameters like Temperature Difference.  |
| Interface Managers           |  |
| MDSE                         | The MDSE (Medical Data Service Element) Interface Manager is responsible for the exchange of real-time data between the IntelliVue Patient Monitoring System display unit and the Measurement parameters and other devices attached to the network. MDSE establishes and maintains a data communication link between the devices. It provides configuration information about the remote device to applications in the local device and it allows the exchange of measurement data and status information between the devices.   |
| Printer                      | <p>The Printer Interface Manager provides a high level interface to a printer. It provides means to:</p> <ul style="list-style-type: none"> <li>- establish a connection to the printer</li> <li>- transfer data to the printer</li> <li>- get status of the printer</li> <li>- close connection to the printer</li> </ul> <p>The Printer Interface Manager also supervises the connection to the printer and whether the printer accepts data (for example paper out). The Printer Interface Manager notifies the operator in such cases.</p>   |
| Display & Operator Interface | <p>The Display and Operator Interface Manager performs the following tasks:</p> <ul style="list-style-type: none"> <li>- Screen presentation of real-time and stored physiological measurement data, alarm condition data and status information received from the MDSE interface manager, the Alarm service or other IntelliVue Patient Monitoring System modules</li> <li>- Screen presentation of operating controls (control windows)</li> <li>- Processing of operating control commands received from HIF Control interface. The module verifies and interprets the received commands and forwards them to other software modules of the IntelliVue Patient Monitoring System display unit or measurement parameters.</li> <li>- Sound generation (issues audible alarm signals and generates audible information signals, for example QRS and SpO2 tones, operator audible feedback)</li> </ul> |

| Functional Block                    | Description  |
|-------------------------------------|--|
| Interfaces                          |  |
| LAN                                 | The LAN interface implements the physical layer of IEEE 802.3. The LAN interface performs Manchester encoding/decoding, receive clock recovery, transmit pulse shaping, jabber, link integrity testing, reverse polarity detection/correction, electrical isolation, and ESD protection. Electronically separated interfaces are used for communication to the Measurement parameters and to the network.  |
| Display Controller                  | The Display Controller Interface consists of a video controller, video RAM and the controlling software. The Display Controller interface processes the high level display commands (character and graphic generation, wave drawing) and translates them into pixels, which are written into the video RAM where the video controller chip generates the video synchronization signals and the pixel stream for the Color LCD Display.   |
| HIF Control                         | The HIF (Human Interface Control) interface scans the Human Interface devices for operator controls (Touch Screen), formats the collected data and sends it to the display and Operating Interface.  |
| ECG-Out Marker-In<br>(not for MP5T) | The ECG Out/Marker In interface receives the ECG waveform directly from the ECG/Resp Arrhythmia ST-Segment physiological algorithm running on the main CPU and converts the digital ECG signal to an analog ECG signal. In addition, the ECG Out hardware receives from a connected device the marker information and forwards this data to the ECG/Resp Arrhythmia ST-Segment physiological algorithm. The converted analog signal is used to synchronize a connected device to the patient's ECG |
| Nurse Call<br>(not for MP5T)        | The Nurse Call board contains a phone jack type connector with a single close-on-alarm relay.  |
| MIB<br>(not for MP5T)               | The MIB interface allows full-duplex, short-haul asynchronous binary communication between the monitor and an arbitrary (medical/non-medical) device using an eight-pin RJ45 modular connector. Communication protocols using this interface can be configured.  |
| ECG Sync Out<br>(not for MP5T)      | A pulse signal is provided on the RS-232 interface to allow synchronisation with other medical devices.  |
| IIT<br>(not for MP5T)               | The built-in IIT adapter allows operation of the MP5 monitors within IntelliVue Instrument Telemetry infrastructure.   |

| Functional Block       | Description  |
|------------------------|--|
| WLAN<br>(not for MP5T) | The built-in WLAN interface allows wireless operation of the MP5 monitors with the IntelliVue 802.11 Bedside Adapter.  |
| SRR                    | The built-in SRR interface allows wireless communication of the MP5 and MP5T monitors with an IntelliVue Instrument Telemetry Transceiver.   |
| MSL<br>(not for MP5T)  | All components of the monitoring system communicate using an IEEE802.3/ Ethernet LAN in the Measurement Link (MSL). This network is used to distribute data between the components |





---

# Testing and Maintenance

## Introduction

This chapter provides a checklist of the testing and maintenance procedures to ensure the performance and safety of the monitor.

These tests must be performed only by qualified personnel certified by the responsible organization. Qualifications required are: training on the subject, knowledge, experience and acquaintance with the relevant technologies, standards and local regulations. The personnel assessing safety must be able to recognize possible consequences and risks arising from non-conforming equipment.

All recurring safety and performance assurance tests must be performed under equal environmental conditions to be comparable.

Preventive Maintenance refers specifically to the series of tests required to make sure the measurement results are accurate. The accuracy and performance procedures are designed to be completed as specified in the following sections or when readings are in question.

For detailed instructions on the maintenance and cleaning of the monitor and its accessories, see *Care and Cleaning, Using Batteries and Maintenance and Troubleshooting* in the monitor's *Instructions for Use*.

# Terminology and Definitions

The following terms and definitions are used throughout this chapter and taken from the international standards IEC 60601-1, IEC 60601-1-1 and IEC 62353.

- **Medical System:** a medical electrical system is a combination of at least one medical electrical device and other electrical equipment, interconnected by functional connection or use of a multiple portable socket-outlet.
- **Patient Vicinity:** any area in which intentional or unintentional contact can occur between the patient and parts of the medical system or between the patient and other persons who have had contact with parts of the medical system. The patient vicinity is defined anywhere within 1.5m (5 feet) of the perimeter of the patient's bed and 2.5m (8.2 feet) from the floor.
- **Separation Device/Transformer:** a component or arrangement of components with input parts and output parts that, for safety reasons, prevent a transfer of unwanted voltage or current between parts of a medical system.
- **Multiple Portable Socket-Outlet:** a combination of two or more socket-outlets intended to be connected to or integrated with flexible cables or cords, which can easily be moved from one place to another while connected to the power mains.
- **Functional Connection:** an electrical connection for transfer of signals and/or power.
- **Tests:** Safety or Performance Assurance test procedures which may consist of several steps.



## Recommended Frequency

Perform the procedures as indicated in the suggested testing timetable. These timetable recommendations do not supersede local requirements.

**Table 1: Suggested Testing Timetable**

| Tests                       |  | Frequency  |   |
|-----------------------------|--|--|---|
| Preventive Maintenance      | NBP Performance  | Once every two years, or more often if specified by local laws.  |   |
|                             | Microstream CO <sub>2</sub> Calibration                  | <b>Once a year</b> or after <b>4000 hours</b> of continuous use and following any instrument repairs or the replacement of any instrument parts.   |   |
| Other Regular Tests         | Visual Inspection  | Before each use.   |   |
|                             | Power On Test  |  |   |
| Performance Assurance Tests | ECG/Resp Performance                                     | Once every two years, or if you suspect the measurement is incorrect, except Mainstream CO <sub>2</sub> Accuracy Check, Sidestream CO <sub>2</sub> Accuracy Check and Flow Check - required once a year. |   |
|                             | ECG Sync Pulse Performance                               |  |   |
|                             | SpO <sub>2</sub> Performance                             |  |   |
|                             | NBP Performance  |  |   |
|                             | Invasive Pressure Performance                            |  |   |
|                             | Temperature Accuracy                                     |  |   |
|                             | Mainstream CO <sub>2</sub> Accuracy Check                |  |   |
|                             | Sidestream CO <sub>2</sub> Accuracy Check and Flow Check |  |   |
|                             | Microstream CO <sub>2</sub> Performance Test             |  |   |
|                             | Nurse Call Relay Performance                             |  |   |
| Safety Tests                | Visual   | Visual Inspection  | After each service event  |
|                             | Electrical   | Protective Earth   | Once every two years and after repairs where the power supply has been removed or replaced or the monitor has been damaged by impact. |
|                             |  | Equipment Leakage Current  |   |
|                             |  | Patient Leakage Current  |   |
|                             |  | System Test  | Once every two years  |

## When to Perform Tests

This table tells you when to perform specific tests. The corresponding test procedures are described in the following sections **All tests listed below must be performed on the monitor.**

### When to perform tests

| <b>Service Event</b><br><b>(When performing...</b>   | <b>Tests Required</b><br><b>...Complete these tests)</b>  |
|--|---|
| <b>Installation</b>  |   |
| <b>Installation</b> of a monitor in combination with a medical or non-medical device connected to the same multiple socket outlet. | Perform Visual Inspection, Power On and System Tests  |
| <b>Installation</b> of a standalone monitor with <b>no</b> display connected to the video output                                   | Perform Visual Inspection and Power On Test   |
| <b>Installation</b> of a monitor with a medical display specified by Philips   | Perform Visual Inspection and Power On Test   |
| <b>Installation</b> of a monitor with an off-the-shelf display (non-compliant with IEC60601-1)                                     | Perform Visual Inspection, Power On and System Test   |
| <b>Installation</b> of a monitor with IntelliVue G1/G5, connected to separate mains sockets.                                       | Perform Visual Inspection and Power On Tests  |
| <b>Installation</b> of monitor with IntelliVue Instrument Telemetry (IIT)  | Perform Visual Inspection, Power On and IIT communication test  |
| <b>Installation</b> of a monitor with IT equipment e.g. PC connected via a functional connection e.g. Centronics or USB.           | Perform Visual Inspection, Power On and System Tests  |
| <b>Installation</b> of monitor with IntelliVue 802.11 Bedside Adapter  | Perform Visual Inspection, Power On and IntelliVue 802.11 Bedside Adapter Communication Test  |
| <b>Installation</b> of a monitor with Short Range Radio (SRR)  | Perform Visual Inspection, Power On and SRR communication test  |
| <b>Installation</b> of networked monitor (LAN)   | Perform Visual Inspection and Power On Test   |
| <b>Preventive Maintenance</b>  |   |
| Preventive Maintenance*  | Perform preventive maintenance tests and procedures: <ul style="list-style-type: none"> <li>- NBP calibration</li> <li>- Microstream CO2 calibration</li> </ul> |

| <b>Service Event</b><br><b>(When performing...</b>   | <b>Tests Required</b><br><b>...Complete these tests)</b>  |
|--|---|
| <b>Other Regular Tests and Tasks</b>   |   |
| Visual Inspection  | Perform Visual Inspection   |
| Power On Test  | Perform Power On test   |
| <b>Repairs</b>   |   |
| <b>Repairs</b> where the monitor has been damaged by impact, liquid ingress, fire, short circuit or electrical surge.  | Perform Visual Inspection, Power On, all Safety Tests and Full Performance Assurance Tests  |
| <b>Repairs</b> where the power supply, the mains socket or an interface board is removed or replaced or the protective earth ground connection is disrupted. | Perform Visual Inspection, Power On, all Safety Tests and Basic Performance Assurance Test  |
| <b>Repairs</b> where the main board has been replaced.   | Perform Visual Inspection, Power On, Basic Performance Assurance Test and NBP Accuracy Test and Calibration.  |
| <b>Repairs</b> where the measurement block has been removed or replaced  | Perform Visual Inspection, Power On, all Safety Tests and Basic Performance Assurance Test.<br>If a certain parameter seems suspicious, perform Full Performance Assurance Test for this parameter. |
| <b>Repairs</b> where the NBP pump has been replaced  | Perform Visual Inspection, Power On, all Safety Tests, Basic Performance Assurance Test and NBP Performance Test and Calibration  |
| <b>Repairs</b> of IntelliVue Instrument Telemetry (IIT) Module   | Perform Visual Inspection, Power On Test Block and IIT communication test   |
| <b>Repairs</b> of IntelliVue 802.11 Bedside Adapter  | Perform Visual Inspection, Power On and IntelliVue 802.11 Bedside Adapter Communication Test  |
| <b>Repairs</b> of Short Range Radio (SRR) Interface  | Perform Visual Inspection, Power On and SRR Communication Test  |
| <b>Repairs</b> of the IntelliVue G1/G5   | Perform Basic Performance Assurance Test. For further testing requirements, see IntelliVue G1/G5 Service Guide  |
| All other IntelliVue Monitoring System repairs (except when power supply is removed)   | Perform Visual Inspection, Power On Test and Basic Performance Assurance Test   |

| <b>Service Event</b><br><b>(When performing...</b>  | <b>Tests Required</b><br><b>...Complete these tests)</b>  |
|---|---|
| <b>Performance Assurance</b>  |   |
| Basic Performance Assurance   | Perform basic performance assurance tests for the respective monitoring system component.   |
| Full Performance Assurance  | Perform all accuracy and performance test procedures listed in the following sections. If a particular measurement is in question, perform the measurement performance test only. |
| <b>Upgrades</b>   |   |
| <b>Software Upgrades</b>  | Perform Visual Inspection, Power On Test and Basic Performance Assurance Test unless otherwise specified in the Upgrade Installation Notes shipped with the upgrade.              |
| <b>Hardware Upgrades</b>  | Perform Visual Inspection, Power On Test and Basic Performance Assurance Test unless otherwise specified in the Upgrade Installation Notes shipped with the upgrade.              |
| <b>Hardware Upgrades</b> where IntelliVue Instrument Telemetry (IIT) is installed                                     | Perform Visual Inspection, Power On Test, Basic Performance Assurance Test and IIT communication Test   |
| <b>Hardware Upgrades</b> where IntelliVue 802.11 Bedside Adapter is installed   | Perform Visual Inspection, Power On Test, Basic Performance Assurance Test and IntelliVue 802.11 Bedside Adapter Communication Test   |
| <b>Hardware Upgrades</b> where Short Range Radio (SRR) is installed   | Perform Visual Inspection, Power On Test, Basic Performance Assurance Test and SRR communication Test   |
| Installation of Interfaces or <b>Hardware Upgrades</b> where the power supply or parameter boards need to be removed. | Perform Visual Inspection, Power On Test, Basic Performance Tests and all Safety Tests  |
| <b>Combining or Exchanging System Components</b>  | Perform the System Test for the respective system components  |

**NOTE**

It is the responsibility of the facility operator or their designee to obtain reference values for recurring safety and system tests. These reference values are the results of the first test cycles after an installation. You may also purchase this service from Philips.

# Testing Sequence

Summary of the recommended sequence of testing:

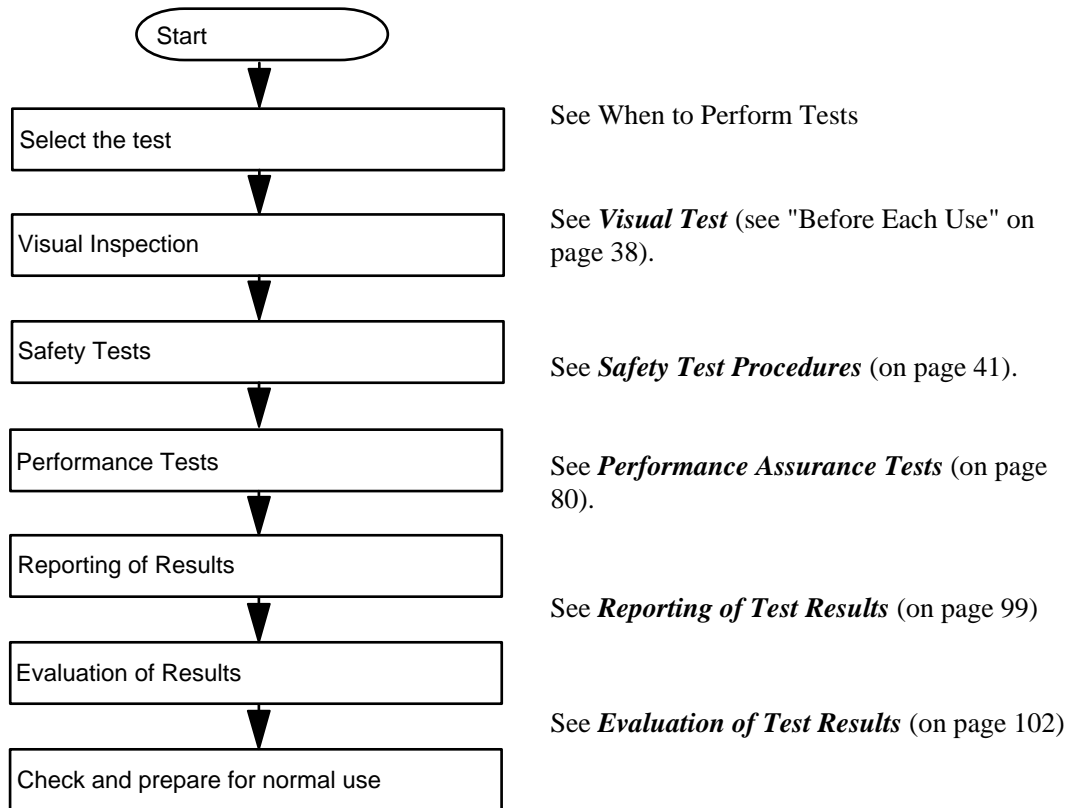

## NOTE

If any single test fails, testing must be discontinued immediately and the device under test must be repaired or labeled as defective.

# Visual Inspection

## Before Each Use

Check all exterior housings for cracks and damage. Check the condition of all external cables, especially for splits or cracks and signs of twisting. If serious damage is evident, the cable should be replaced immediately. Check that all mountings are correctly installed and secure. Refer to the instructions that accompany the relevant mounting solution.

## After Each Service, Maintenance or Repair Event

Ensure all fuses accessible from the outside comply with the manufacturer's specification.

Check:

- the integrity of mechanical parts, internally and externally.
- any damage or contamination, internally and externally
- that no loose parts or foreign bodies remain in the device after servicing or repair.
- the integrity of all relevant accessories.

## Power On Test

1. Connect the monitoring system to mains and switch it on. This includes connected displays and gas analyzers.
2. Make sure that all steps listed in the table *Initial Instrument Boot Phase* in the Troubleshooting section are completed successfully and that an ECG wave appears on the screen.

The expected test result is pass: the monitor boots up and displays an ECG wave. The wave might be a flat line if no simulator is attached.

# Safety Tests

Safety tests are comprised of the following tests performed on the monitoring system:

- protective earth resistance
- equipment leakage current
- applied part leakage current
- system test (if required)

Safety test requirements are set according to international standards, their national deviations and specific local requirements. The safety tests detailed in this Service Guide are derived from international standards but may not be sufficient to meet local requirements. We recommend that you file the results of safety tests. This may help to identify a problem early particularly if the test results deteriorate over a period of time.

Each individual piece of equipment of the monitoring system which has its own connection to mains or which can be connected or disconnected from mains without the use of a tool must be tested individually. The monitoring system as a whole must be tested according to the **System Test** (on page 65) procedure.

Accessories of the monitoring system which can affect the safety of the equipment under test or the results of the safety test must be included in the tests and documented.

## Warnings, Cautions, and Safety Precautions

- These tests are well established procedures of detecting abnormalities that, if undetected, could result in danger to either the patient or the operator.
- Disconnect the device under test from the patient before performing safety tests.
- Disconnect the device under test from mains before performing safety tests. If this is not possible, ensure that the performance of these tests does not result in danger to the safety analyzer operator, patients or other individuals.
- Test equipment (for example, a *Safety Analyzer*) is required to perform the safety tests. Please refer to Annex C of IEC/EN 62353 for exact requirements for the measurement equipment and for measurement circuits for protective earth resistance and leakage currents. Refer to the documentation that accompanies the test equipment. Only certified technicians should perform safety testing.
- The consistent use of a *Safety Analyzer* as a routine step in closing a repair or upgrade is emphasized as a mandatory step to maintain user and patient safety. You can also use the *Safety Analyzer* as a troubleshooting tool to detect abnormalities of line voltage and grounding plus total current loads.
- During safety testing, mains voltage and electrical currents are applied to the device under test. Ensure that there are no open electrical conductive parts during the performance of these tests. Avoid that users, patients or other individuals come into contact with touch voltage.
- For Europe and Asia/Pacific, the monitor complies with:  
IEC60601-1:1988 + A1:1991 + A2:1995 = EN60601-1:1990 +A1:1993 + A2:1995  
IEC60601-1-1:2000  
For USA, the monitor complies with:  
UL60601-1  
For Canada, CAN/CSA C22.2#601.1-M90
- Local regulations supersede the testing requirements listed in this chapter.
- If a non-medical electrical device is connected to a medical electrical device, the resulting medical electrical system must comply with IEC/EN 60601-1-1.
- Perform safety tests as described on the following pages.









### Safety Test Procedures

Use the test procedures outlined here **only** for verifying safe installation or service of the product. The setups used for these tests and the acceptable ranges of values are derived from local and international standards but may not be equivalent. These tests are not a substitute for local safety testing where it is required for an installation or a service event. If using an approved safety tester, perform the tests in accordance with the information provided by the manufacturer of the tester and in accordance with your local regulations, for example IEC/EN 60601-1, UL60601-1 (US), IEC/EN 62353, and IEC/EN 60601-1-1. The safety tester should print results as detailed in this chapter, together with other data.

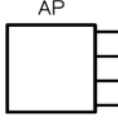
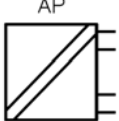
Please refer to Annex C of IEC/EN 62353 for requirements for the measurement equipment and for measurement circuits for protective earth resistance and leakage currents.

The following symbols are used in the diagrams illustrating the safety tests:

|   |                             |   |   |
|---|-----------------------------|---|---|
|    | Supply mains                |   | Protective earth                          |
| L, N  | Supply mains terminals      | PE  | Protective earth terminal                 |
|    | Mains part                  |   | Applied part                              |
|   | F-type applied part         |  | Measuring device                          |
|  | Resistance measuring device |  | Connection to accessible conductive parts |
| .....   | Optional connection         |   |   |

---

#### CAUTION

##### After each service, maintenance or repair event:

Ensure all fuses accessible from the outside comply with the manufacturer's specification.

Check:

- the integrity of mechanical parts, internally and externally.
  - any damage or contamination, internally and externally.
  - that no loose parts or foreign bodies remain in the device after servicing or repair.
  - the integrity of all relevant accessories.
-

### Hints for Correct Performance of Safety Tests

- Perform a visual inspection on all detachable power cords used with the monitoring system and include these in all safety test procedures.
- Connection lines such as data lines or functional earth conductors may appear to act like protective earth connections. These may lead to incorrect measurements and need to be considered during testing. If necessary, unplug these connections.
- Position all cables and cords in such a manner that they do not influence the safety tests.
- Measurement of insulation resistance is not required.

### Guideline for Performance of Safety Tests

Connect the detachable power cord of the device under test to the safety analyzer's test mains port. Connect the enclosure test lead of the safety analyzer to the enclosure of the device under test, e.g. to the equipotential connector. For testing the applied part leakage current, connect all applied parts to the safety analyzer using the appropriate patient lead or adapter cable. For the ECG parameter all ten ECG-leads need to be connected to the safety analyzer. If necessary, use an adapter cable to connect all ten ECG-leads. If necessary, repeat the safety test procedure until all available applied parts have been tested. Refer to the documentation that accompanies the safety analyzer for further details on how to set up and perform the test.

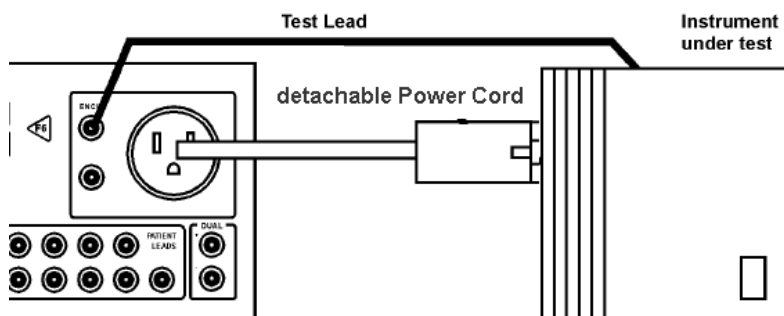

### Protective Earth Resistance Test - Setup Example

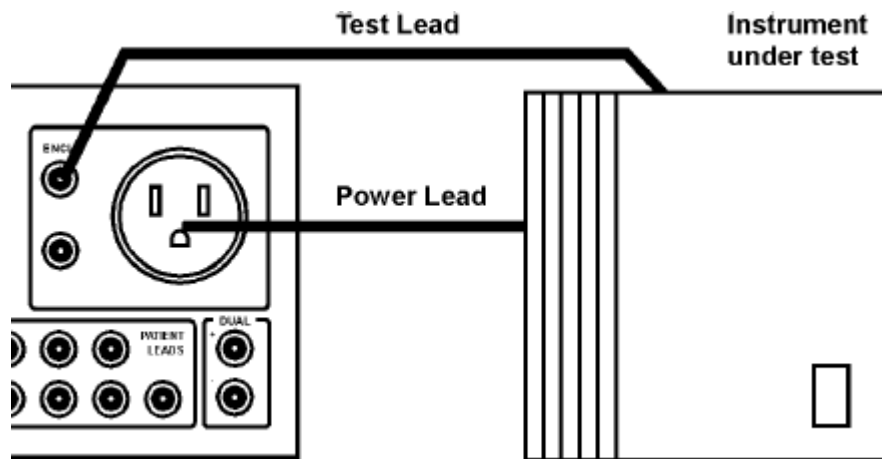

*Equipment Leakage Current Test - Setup Example*

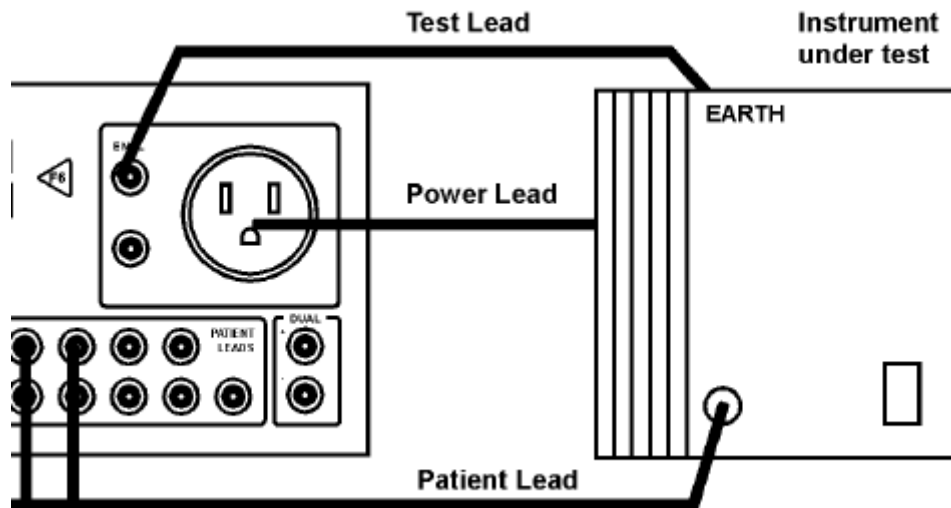

*Applied Part Current Test - Setup Example*

**NOTE**

The above graphics resemble the Metron QA-90 setup and are protected by copyright. Copyright owned by Fluke (Metron).

**Safety Test Adapter Cable - Schematics**

The following graphics provide schematics of safety test (patient lead) adapter cables which can be used for electrical safety testing. These schematics can also be used as a guideline for making your own safety test adapter cables. Alternatively, other methods to make safety test adapter cables can be used, e.g. using a modified accessory cable.

**NOTE**

You may not need all of the cables displayed below for electrical safety testing of your respective monitor.

**ECG:**

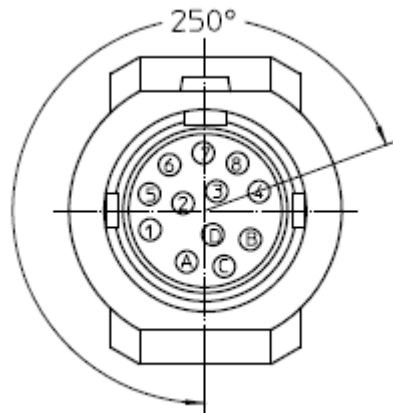

Wiring Schematic

PLUG 12-PIN

MALE

Conductor Coloring

Plug Banana

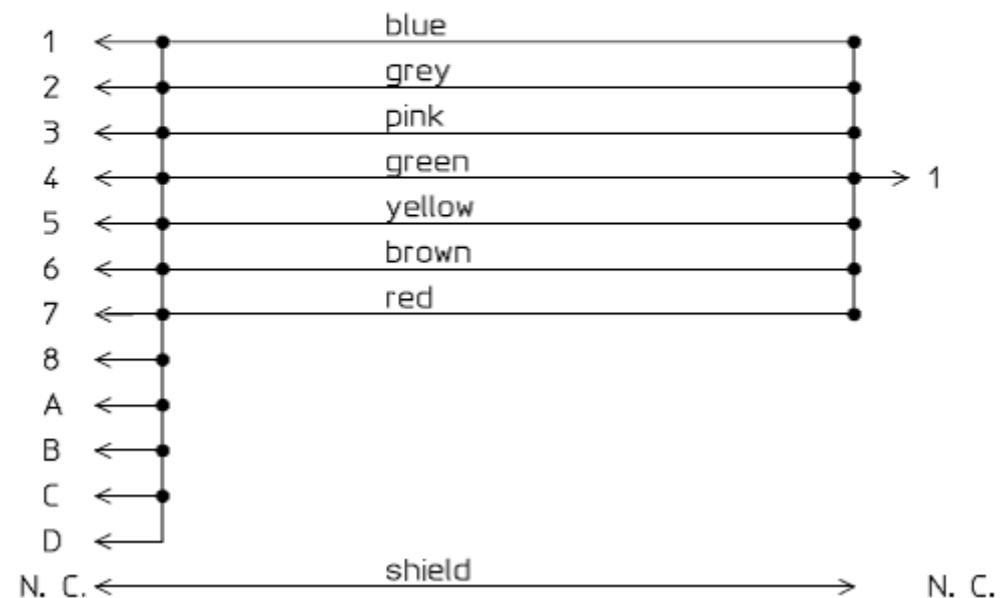

SpO2 (MP2/X2, MP5, M3001A & M1020B #A01, #A02, #A03):

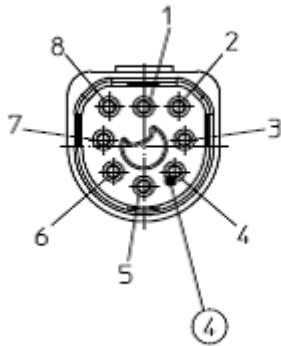

### Wiring Schematic

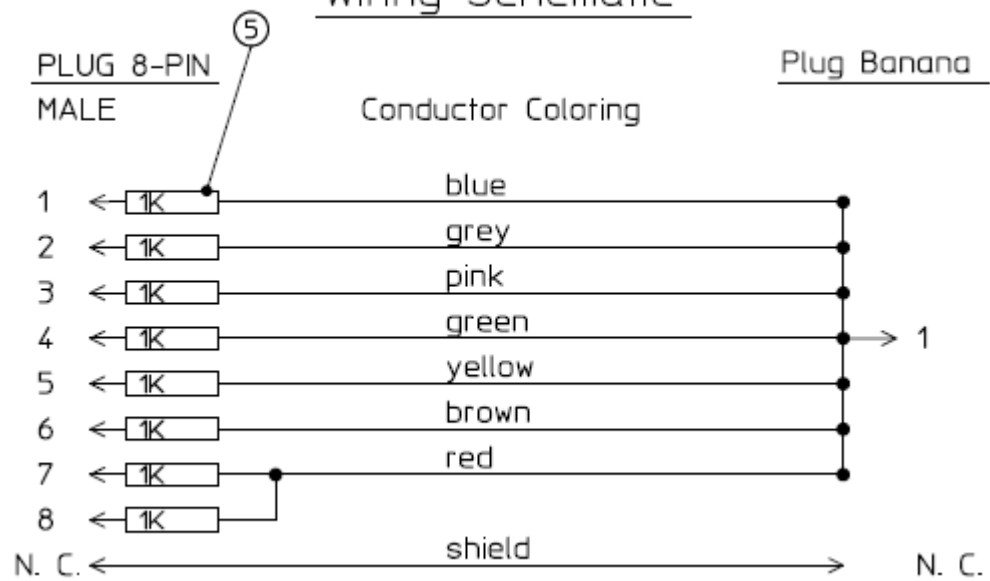

SpO2 (M1020A):

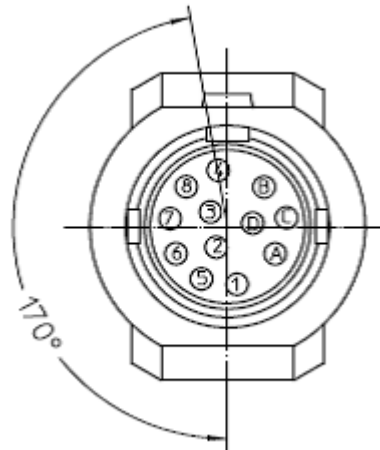

### Wiring Schematic

PLUG 12-PIN  
MALE

Conductor Coloring

Plug Banana

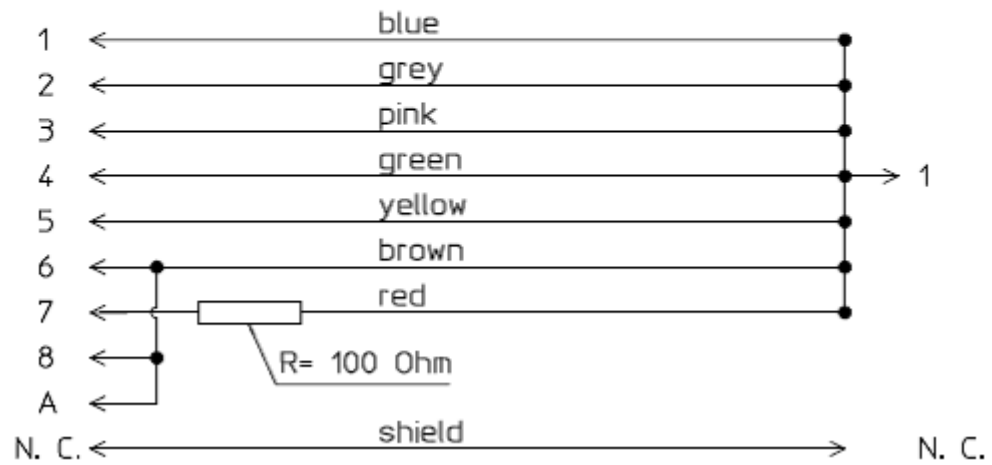

**Invasive Pressure:**

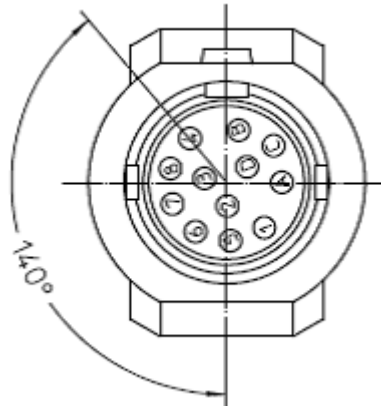

Wiring Schematic

PLUG 12-PIN  
MALE

Conductor Coloring

Plug Banana



**M1006B #C01:**

Wiring Schematic



Temperature:



Wiring Schematic

Plug 2-Contact  
Male

Conductor Coloring

Plug Banana





CO2 (MP5, M3014A):

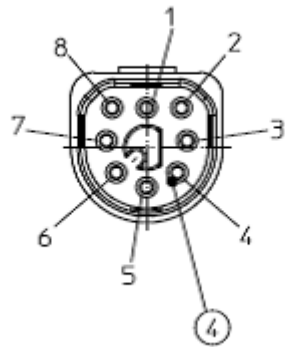

Wiring Schematic

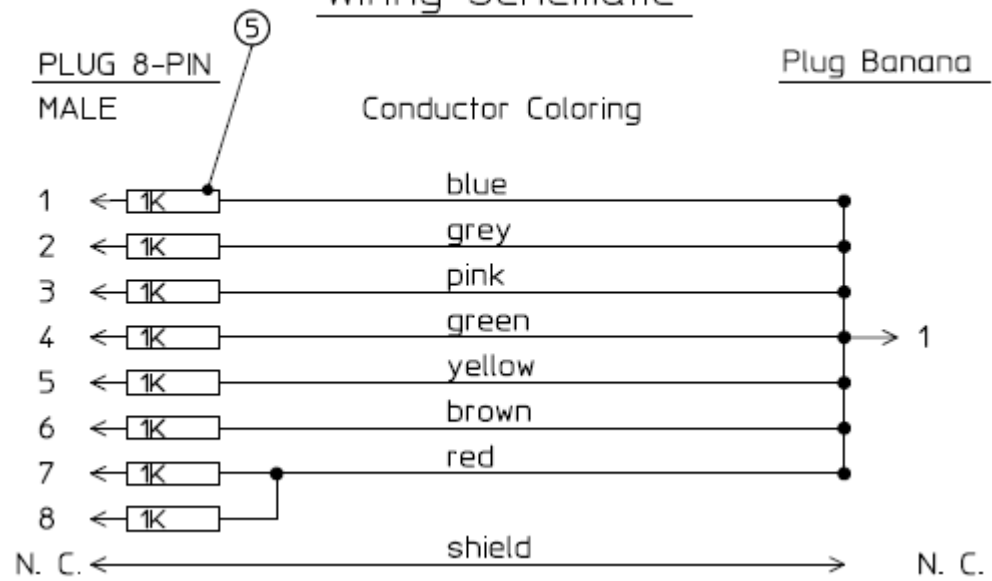

CO2 (M1016A, M3016A):

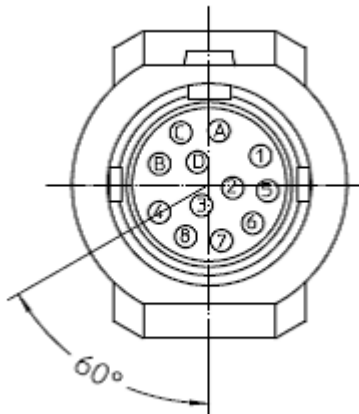

Wiring Schematic

PLUG 12-PIN

MALE

Conductor Coloring

Plug Banana

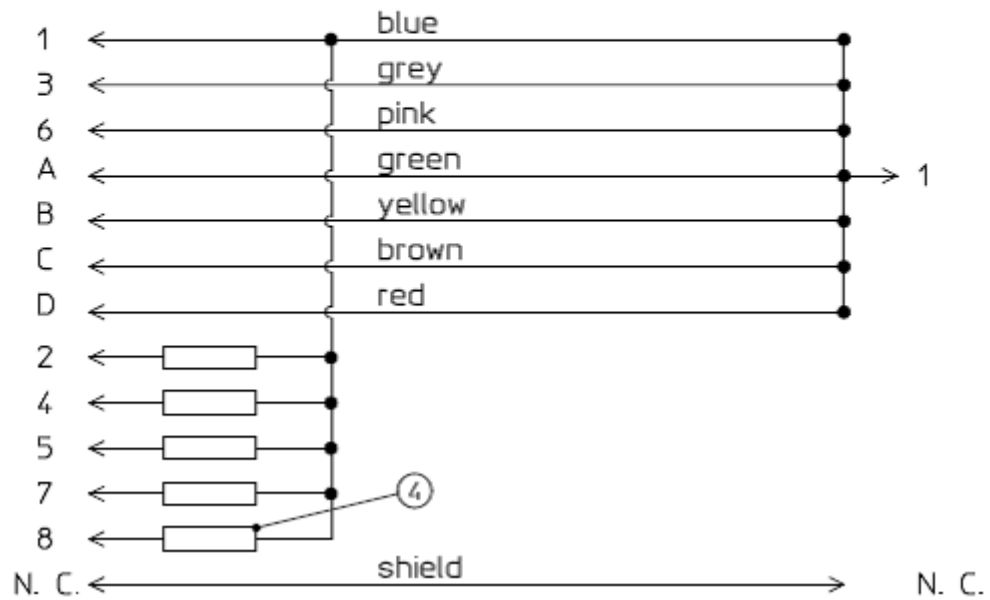

4 = all resistors 120 KOhm

**Cardiac Output:**

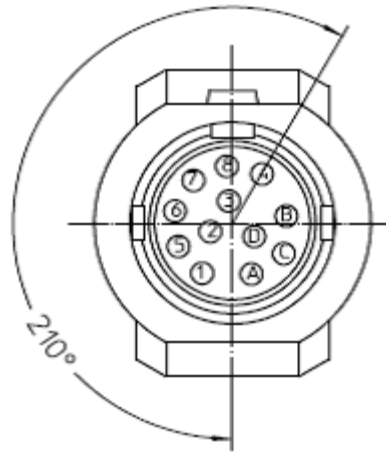

Wiring Schematic

PLUG 12-PIN

MALE

Conductor Coloring

Plug Banana

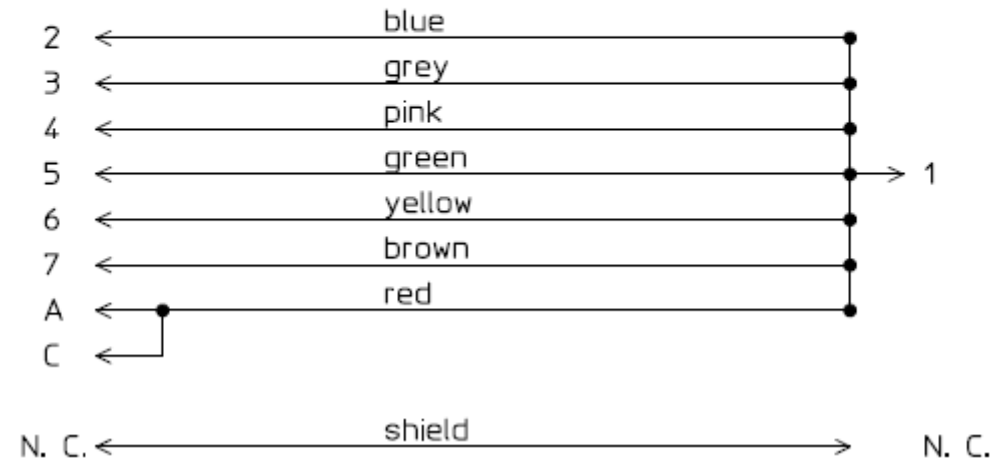

**BIS:**

Use Clamp Adapter Cable and M1034-61650 BIS sensor simulator.

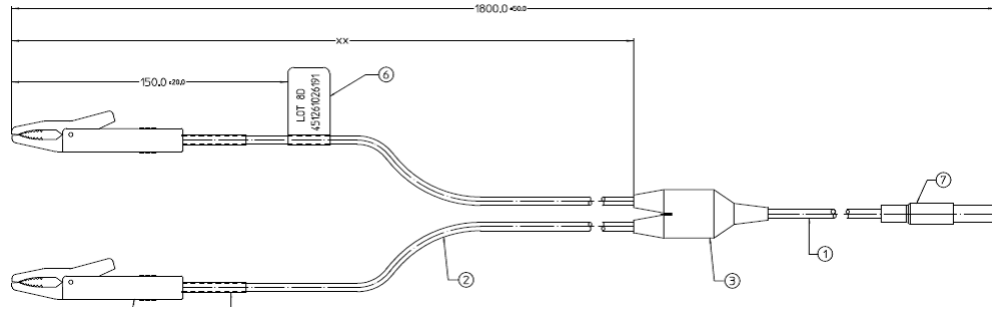

Wiring Schematic

Clamp

Divider

Plug Banana

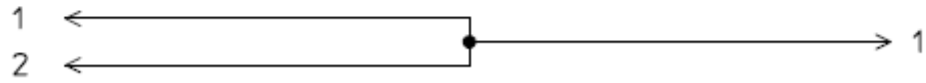

VueLink:

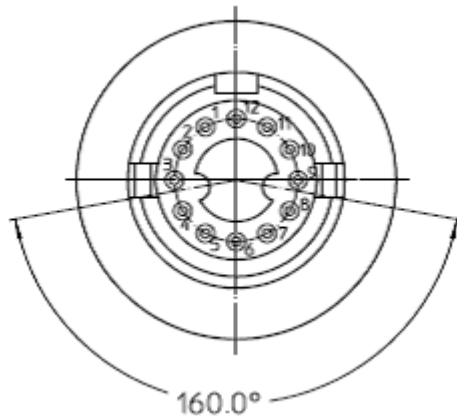

### Wiring Schematic

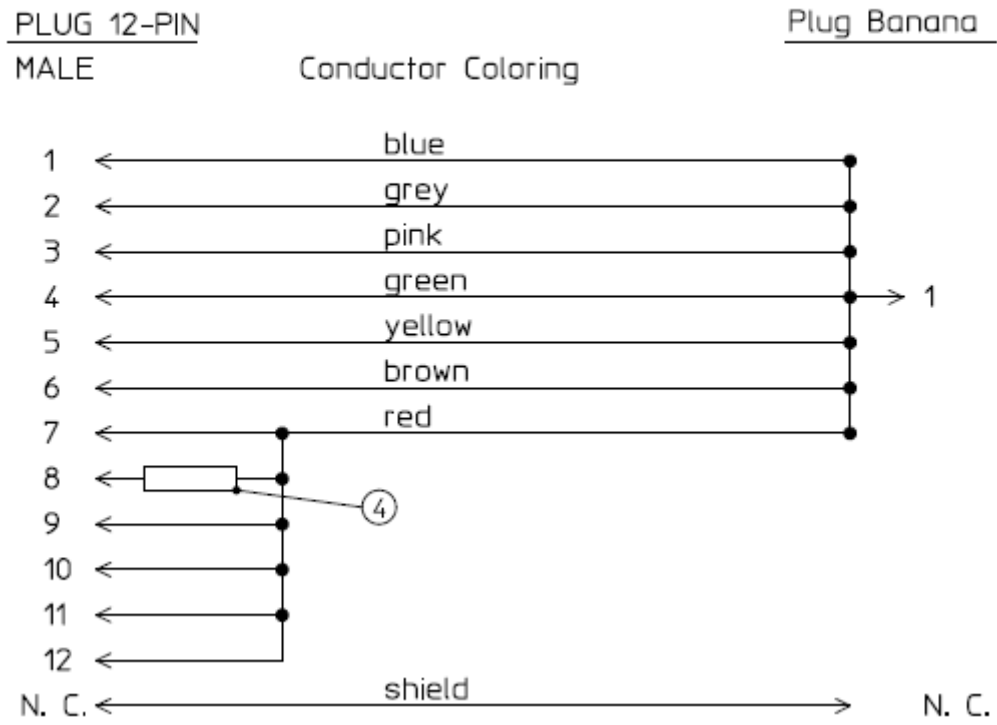

4 = 220 Ohm

**IntelliBridge:**

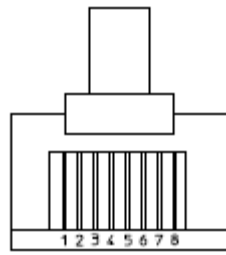

Wiring Schematic

Plug RJ-45

Plug Banana

Conductor Coloring



**EEG:**

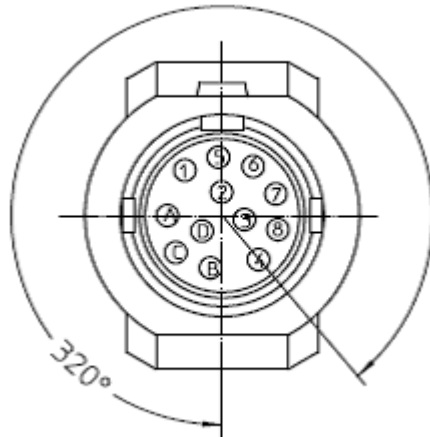

Wiring Schematic

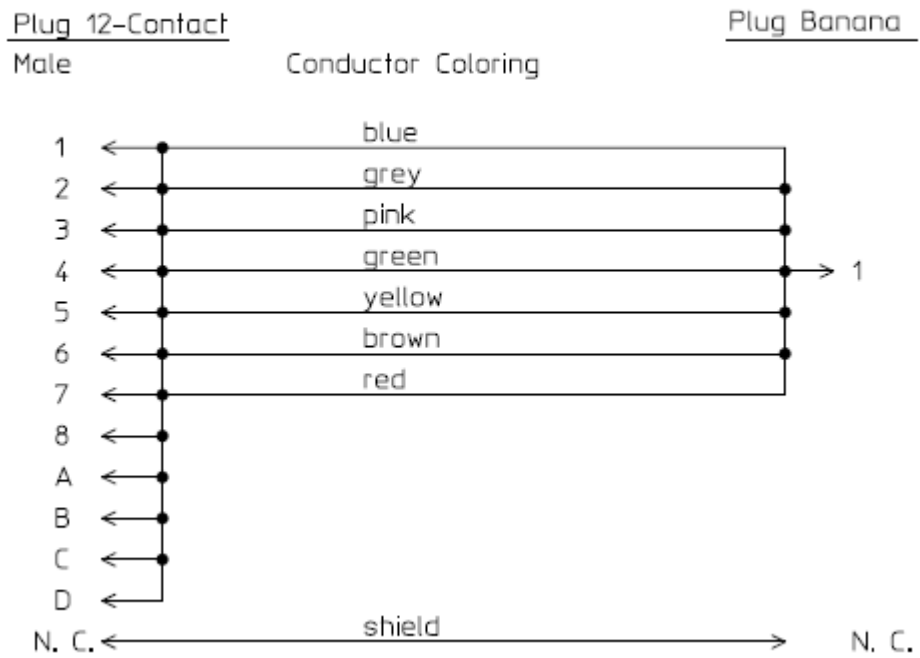

SvO2 (M1021A):

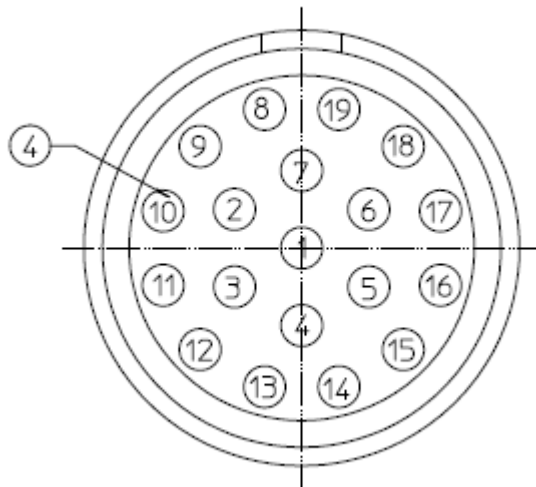

Wiring Schematic

Plug 19-Contact  
Male

Conductor Coloring

Plug Banana

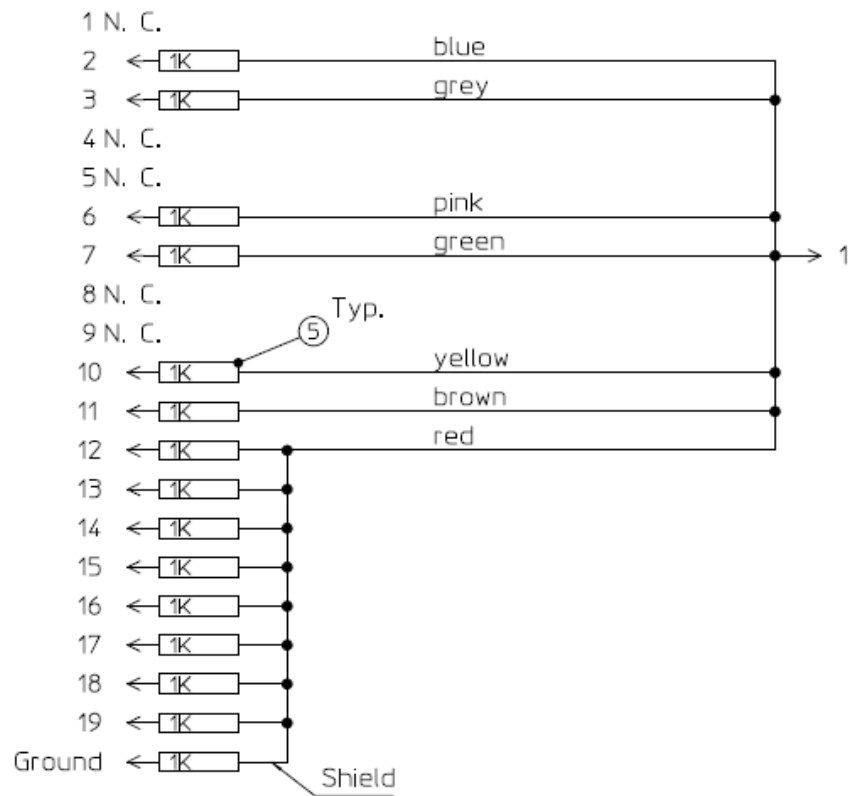



ScvO2 (M1011A):

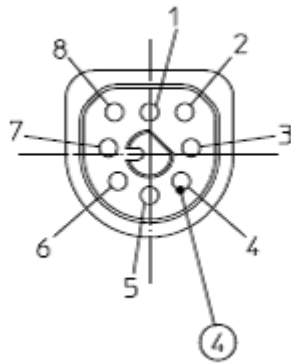

Wiring Schematic

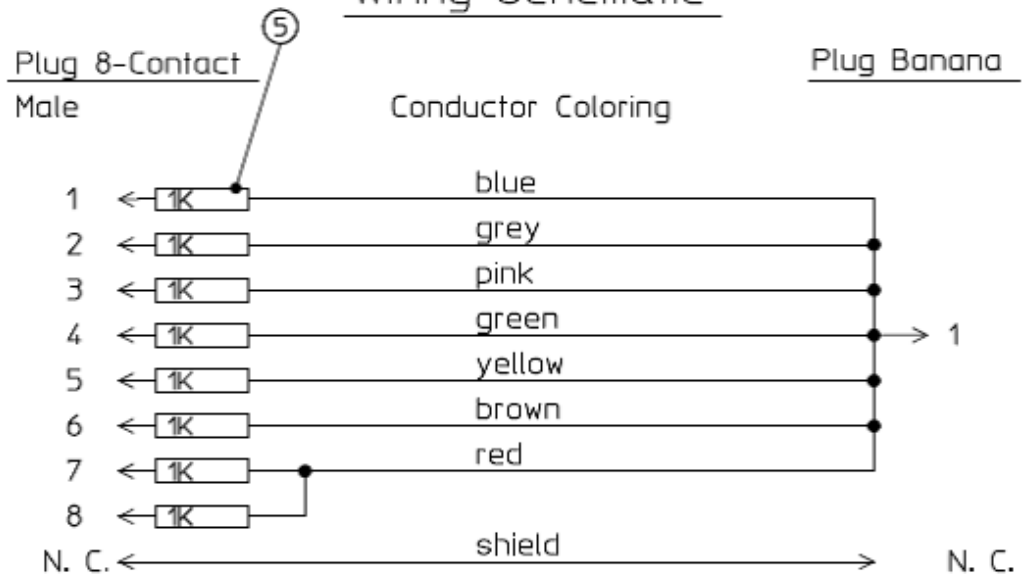

tcpO2/tcpCO2:

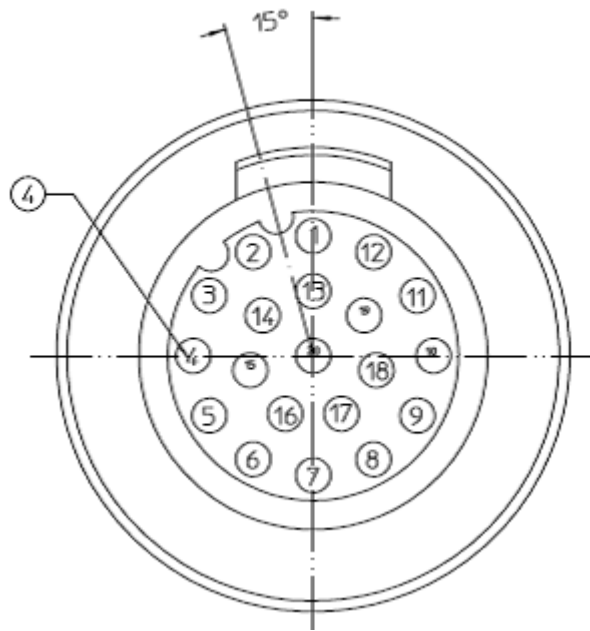

1  
Wiring Schematic

Plug 20-Contact  
Male

Conductor Coloring

Plug Banana

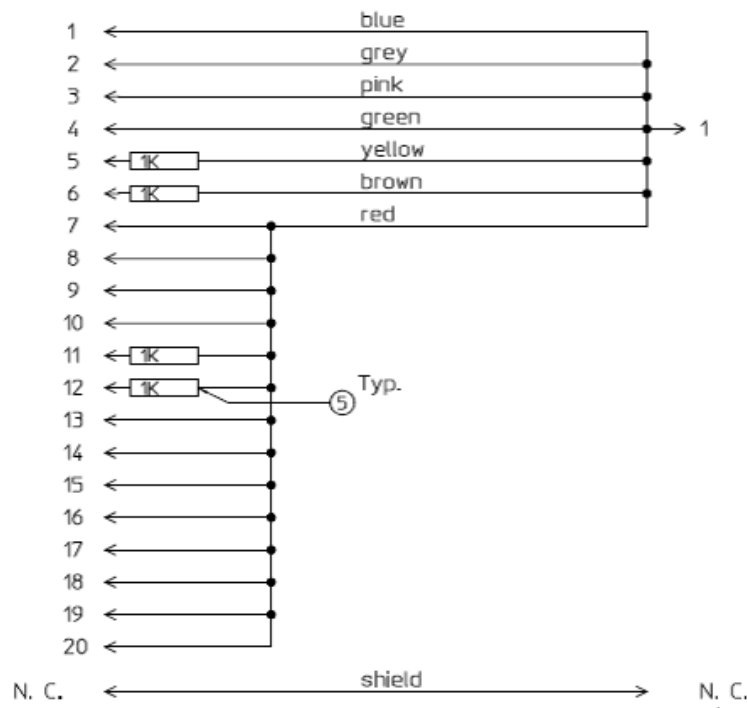

**MP5 predictive Temperature:**

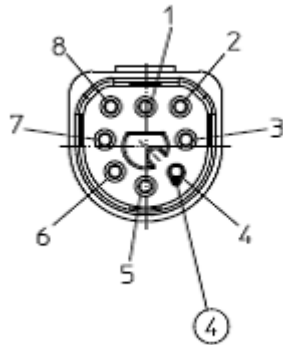

Wiring Schematic

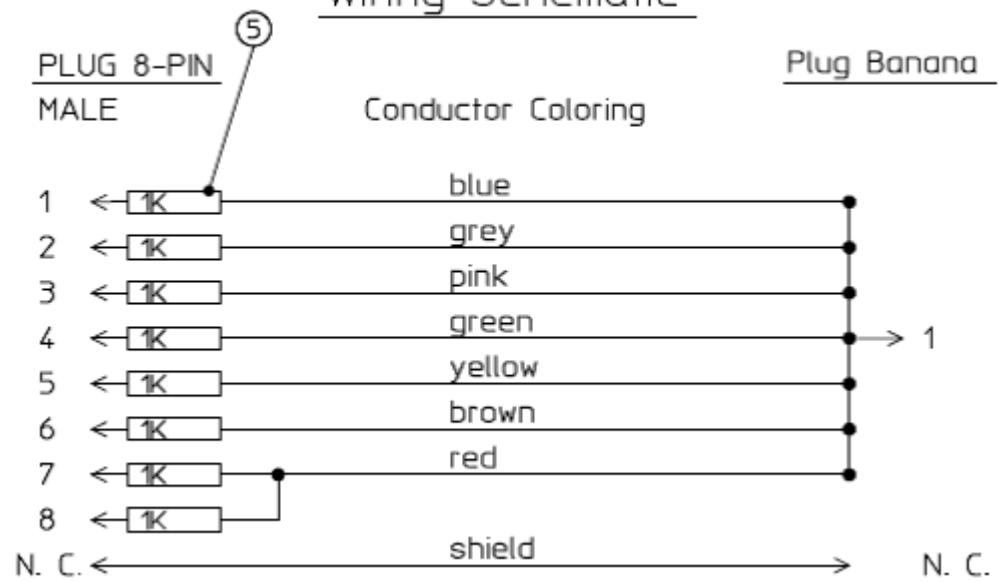

**MP5 TAAP:**

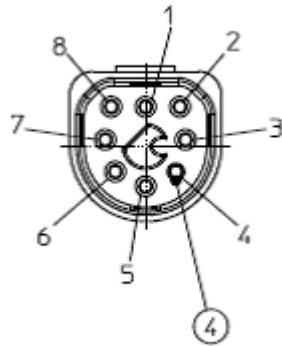

Wiring Schematic

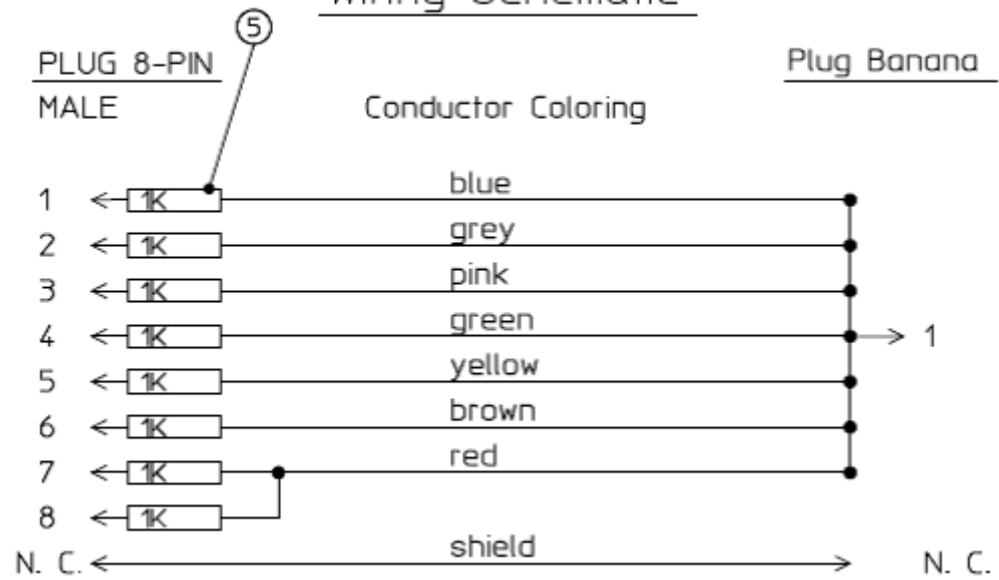

**S(1): Protective Earth Resistance Test**

Test to perform:

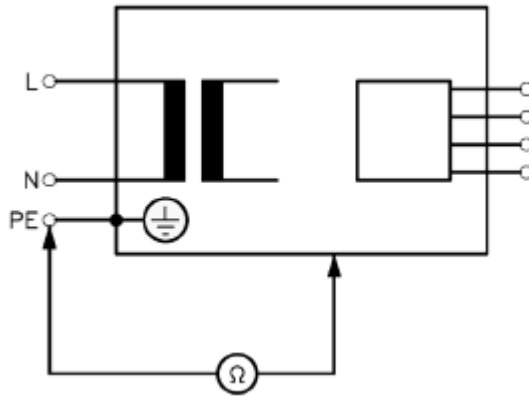

**Measuring circuit for the measurement of Protective Earth Resistance in medical electrical equipment that is disconnected from the supply mains.**

This measures the impedance of the Protective Earth (PE) terminal to all exposed metal parts of the Instrument under Test (IUT), which are for safety reasons connected to the Protective Earth (PE).

Measurements shall be performed using a measuring device capable to deliver a current of at least 200 mA into 500 mOhms with maximum 24V

This safety test is based on IEC/EN 60601-1, IEC/EN 62353, *UL2601-1 Ed. 2/UL60601-1:2003 and CSA 601.1-M90.*

For measurement limits, refer to Safety (1) test, Test and Inspection Matrix.

Report the highest value (X1).

| Test  | Expected test results |
|---|-----------------------|
| Protective Earth Resistance Test (with mains cable) | X1 <= 300mOhms        |

**NOTE**

- If the protective earth resistance test fails, testing must be discontinued immediately and the device under test must be repaired or labeled as defective.
- All values for current and voltage are the root mean square (r.m.s.) values, unless otherwise stated.
- Flex the power cord during the protective earth resistance test to evaluate its integrity. If it does not pass the test, exchange the power cord.

**S(2): Equipment Leakage Current Test - Normal Condition**

Test to perform:

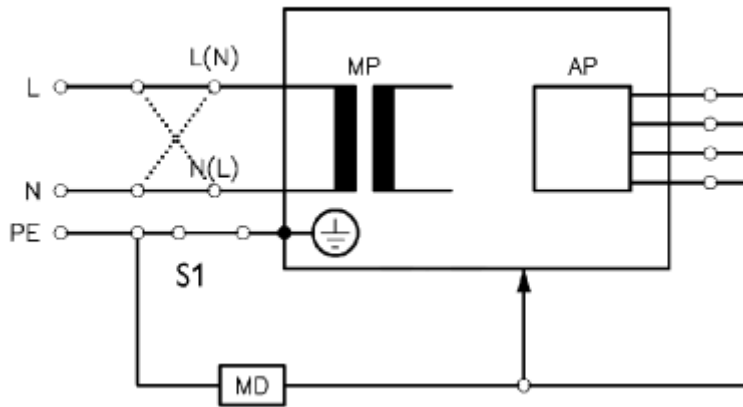

**Measuring circuit for the measurement of Equipment Leakage Current - Direct method according to IEC/EN 62353.**

This test measures leakage current of exposed metal parts of the monitor and the functional earth leakage current. It tests normal and reversed polarity. Perform the test with S1 closed (Normal Condition).

There are no parts of the equipment that are not protectively earthed.

This safety test is based on IEC/EN 60601-1, IEC/EN 62353, *UL2601-1 Ed. 2/UL60601-1:2003 and CSA 601.1-M90.*

For measurement limits, refer to Safety (2) test, Test and Inspection Matrix.

Report the highest value (X1).

| Test   | Expected test results |
|--|-----------------------|
| Equipment Leakage Current Test (Normal Condition - with mains cable) | X1 ≤ 100µA            |

**NOTE**

All values for current and voltage are the root mean square (r.m.s.) values, unless otherwise stated.

**S(3): Equipment Leakage Current Test - Single Fault Condition**

Test to perform:

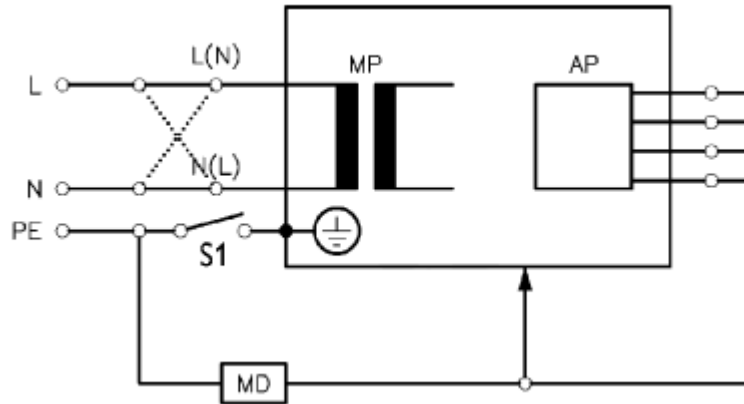

**Measuring circuit for the measurement of Equipment Leakage Current - Direct method according to IEC/EN 62353.**

This test measures leakage current of exposed metal parts of the monitor and the functional earth leakage current. It tests normal and reversed polarity. Perform the test with S1 open (Single Fault Condition).

There are no parts of the equipment that are not protectively earthed.

This safety test is based on IEC/EN 60601-1, IEC/EN 62353, *UL2601-1 Ed. 2/UL60601-1:2003 and CSA 601.1-M90.*

For measurement limits, refer to Safety (3) test, Test and Inspection Matrix.

Report the highest value (X2).

| Test   | Expected test results |
|--|-----------------------|
| Equipment Leakage Current Test (Single Fault Condition - with mains cable) | X2 ≤ 300µA            |

**NOTE**

All values for current and voltage are the root mean square (r.m.s.) values, unless otherwise stated.

**S(4): Applied Part Leakage Current - Mains on Applied Part****NOTE**

During measurement of the Applied Part Leakage Current it is possible that the measured current can exceed the allowed limit (per IEC/EN 60601-1 or IEC/EN 62353).

This can occur when the safety tester is connected to the invasive blood pressure and temperature connectors at the same time during the applied leakage current measurement.

The connectors for the invasive blood pressure and temperature are independently functioning connectors.



Although there are individual connectors on the front end, internally those parameters use the same electrical insulation interface and are hardwired to each other. This results in an electrical short of those connectors during measurement if a test current is applied simultaneously. Therefore this should be avoided.

Due to the combined insulation interface, it is sufficient to connect to only one parameter interface (that is, Invasive Blood Pressure or Temperature) of the invasive blood pressure/temperature measurement block. This avoids a short and the potential of exceeding the limit for the current.

Test to perform:

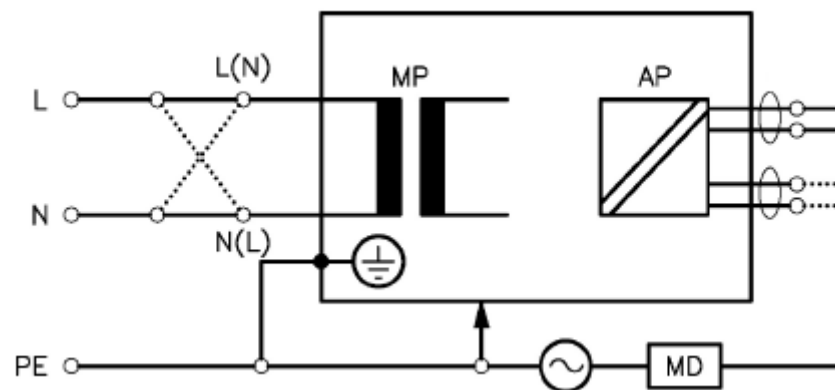



**Measuring circuit for the measurement of Applied Part Leakage Current - Direct method according to IEC/EN 62353.**

This test measures applied part leakage current from applied part to earth caused by external main voltage on the applied part. Each polarity combination possible shall be tested. This test is applicable for ECG measurement inputs.

There are no parts of the equipment that are not protectively earthed.

This safety test is based on IEC/EN 60601-1, IEC/EN 62353, *UL2601-1 Ed. 2/UL60601-1:2003 and CSA 601.1-M90*.

For measurement limits and test voltage, refer to test block Safety (4), Test and Inspection Matrix.

Report the highest value. (X1).

| Test   | Expected test results |
|--|-----------------------|
| Applied Part Leakage Current Test (Single Fault Condition - mains on applied part) | X1 $\leq$ 50 $\mu$ A  |

**NOTE**

All values for current and voltage are the root mean square (r.m.s.) values, unless otherwise stated.

## System Test

After mounting and setting up a system, perform system safety tests according to IEC/EN 60601-1-1.

### What is a Medical Electrical System?

A medical electrical system is a combination of at least one medical electrical piece of equipment and other electrical equipment, interconnected by functional connection or use of a multiple portable socket-outlet.

- Devices forming a medical electrical system must comply with IEC/EN 60601-1-1.
- Any electrical device such as IT equipment that is connected to the medical electrical equipment must comply with IEC/EN 60601-1-1 and be tested accordingly.

## General Requirements for a System

After installation or subsequent modification, a system must comply with the requirements of the system standard IEC/EN 60601-1-1. Compliance is checked by inspection, testing or analysis, as specified in the IEC/EN 60601-1-1 or in this book.

Medical electrical equipment must comply with the requirements of the general standard IEC/EN 60601-1, its relevant particular standards and specific national deviations. Non-medical electrical equipment shall comply with IEC safety standards that are relevant to that equipment.

Relevant standards for some non-medical electrical equipment may have limits for equipment leakage currents higher than required by the standard IEC/EN 60601-1-1. These higher limits are acceptable only outside the patient environment. It is essential to reduce equipment leakage currents to values specified in IEC 60601-1 when non-medical electrical equipment is to be used within the patient environment.

## System Example

This illustration shows a system where both the medical electrical equipment and the non-medical electrical equipment are situated at the patient's bedside.

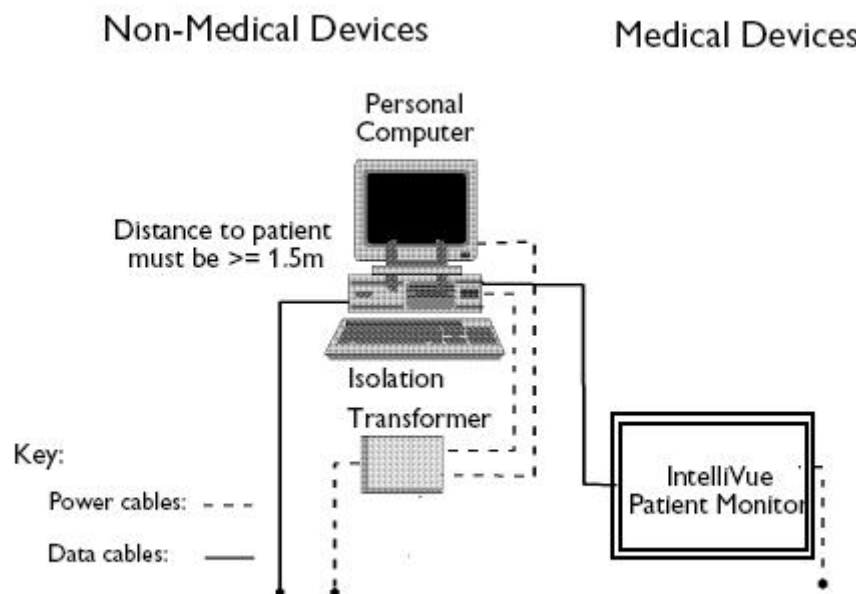

---

**WARNING**

- Do not use additional AC mains extension cords or multiple portable socket-outlets. If a multiple portable socket-outlet is used, the resulting system must be compliant with IEC/EN 60601-1-1. Do not place multiple socket-outlets on the floor. Do not exceed the maximum permitted load for multiple socket-outlets used with the system. Do not plug additional multiple socket outlets or extension cords into multiple socket outlets or extension cords used within the medical electrical system.
  - Do not connect any devices that are not supported as part of a system.
  - Do not use a device in the patient vicinity if it does not comply with IEC/EN 60601-1. The whole installation, including devices outside of the patient vicinity, must comply with IEC/EN 60601-1-1. Any non-medical device placed and operated in the patient's vicinity must be powered via a separating transformer (compliant with IEC/EN 60601-1-1) that ensures mechanical fixing of the power cords and covering of any unused power outlets.
-

## System Installation Requirements

- Ensure that the the medical electrical system is installed in a way that the user achieves optimal use.
- Make sure the user is informed about the required cleaning, adjustment, sterilization and disinfection procedures listed in the Instructions for Use.
- The medical electrical system must be installed in such a way that the user is able to carry out the necessary cleaning, adjustment, sterilization and disinfection procedures listed in the Instructions for Use.
- Ensure that the medical electrical system is installed in a way that an interruption and restoration of power to any part of the medical electrical system does not result in a safety hazard.
- We recommend using fixed mains socket outlets to power the medical system or parts thereof. Avoid using multiple portable socket-outlets.
- Any multiple portable socket outlets used must be compliant with IEC 60884-1 and IEC 60601-1-1.
- Ensure that any part of the system connected to multiple portable socket-outlets is only removable with a tool, i.e. the multiple portable socket-outlet provides a locking mechanism to prevent power cords from being plugged or unplugged unintentionally. Otherwise, the multiple portable socket-outlet must be connected to a separation device. Multiple Socket Outlets used within the medical electrical system must only be used for powering medical electrical equipment which is part of the system.
- Ensure that any functional connections between parts of the medical electrical system are isolated by a separation device according to IEC 60601-1-1 to limit increased equipment leakage currents caused by current flow through the signal connections. This only works if the equipment leakage current of the respective medical electrical system parts is not exceeded under normal conditions.
- Avoid increase of equipment leakage currents when non-medical electrical equipment within the medical electrical system is used. This only works if the equipment leakage current of the respective medical electrical system parts is not exceeded under normal conditions. Use additional protective earth connection, separation device or additional non-conductive enclosures.
- Within the patient environment it is important to limit electrical potential differences between different parts of a system. If necessary, use potential equalization equipment (equipotential cable) or additional protective earth connections.
- Medical electrical equipment used in medical rooms must be connected to potential equalization equipment (equipotential cable) to avoid electrical potential differences. Check your local requirements for details.

### Required Protective Measures at System Installation

For any IT equipment (IEC60950) operated in patient vicinity ensure that the equipment leakage current does not exceed the limits described in IEC 60601-1. Use a separation device to ensure compliance. After installation of IT equipment in patient vicinity, an enclosure leakage current test is required.

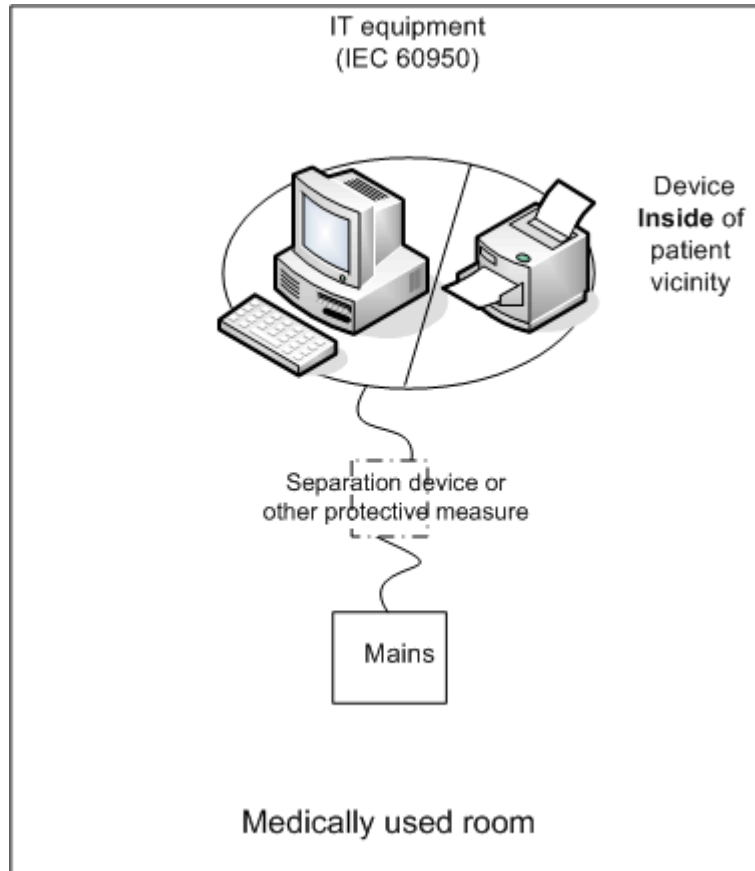

**Case 1: Medical Device Combined with Medical Device**

If you combine a medical device with another medical device (incl. Philips specified displays) to form a medical electrical system according to IEC60601-1, no additional protective measures are required. The medical electrical devices may be located in or outside the patient vicinity in a medically used room. This is valid as long as the medical devices are connected to separate mains outlets. No system test is required.

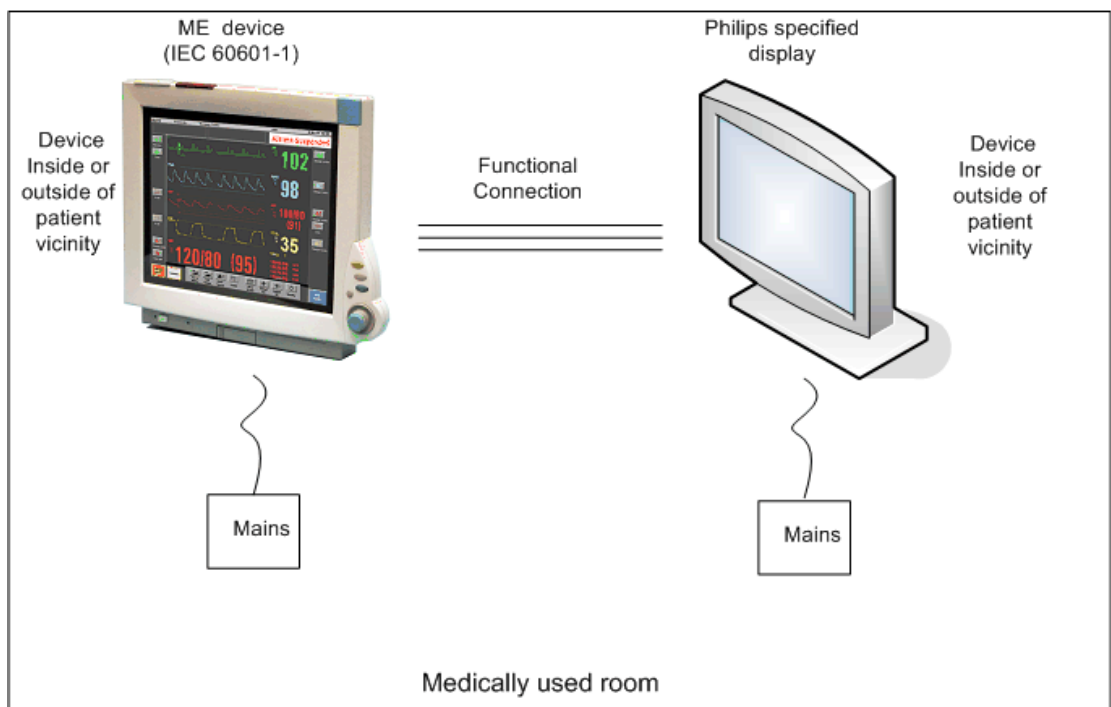
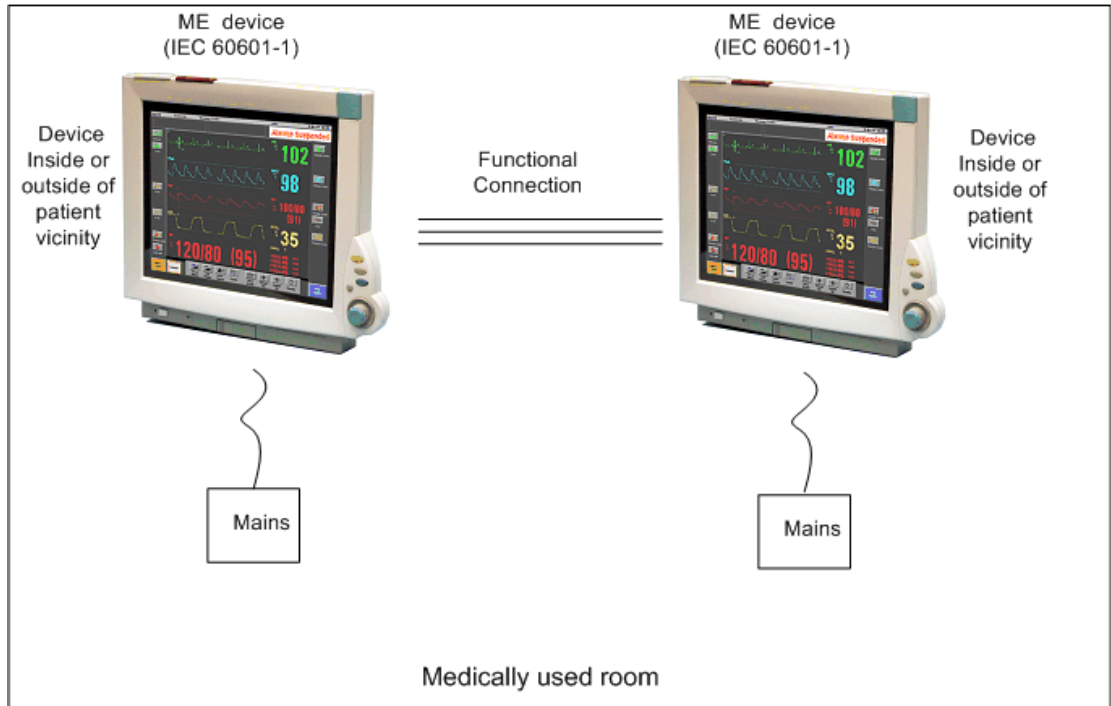

If the combined medical devices are connected to the same multiple portable socket outlet an enclosure leakage current test of the entire device combination on the multiple portable socket outlet is required to ensure that the resulting protective earth leakage current and equipment leakage current does not exceed the limits of IEC 60601-1. Avoid using multiple portable socket outlets. The medical electrical devices may be located in or outside the patient vicinity in a medically used room. If the limits are exceeded, additional protective measures are required, e.g. a separation device or the connection of each device to separate mains.

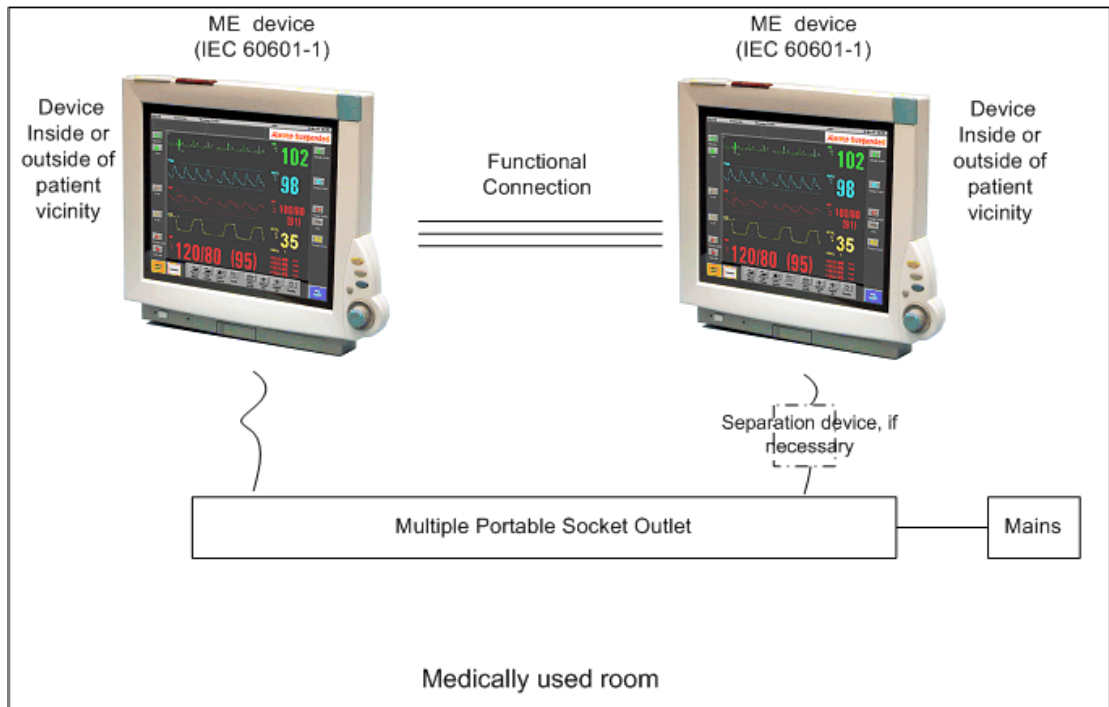

### Case 2: Medical Device Combined with a Non-Medical Device

If you combine a medical device with a non-medical device to form a medical electrical system according to IEC60601-1-1, additional protective measures are required, e.g. usage of a separation device. The medical electrical devices or the IT equipment may be located in or outside the patient vicinity in a medically used room. After system installation incl. protective measures, a system test is required to ensure that the resulting equipment leakage current and applied part leakage current does not exceed the limits of IEC 60601-1-1.

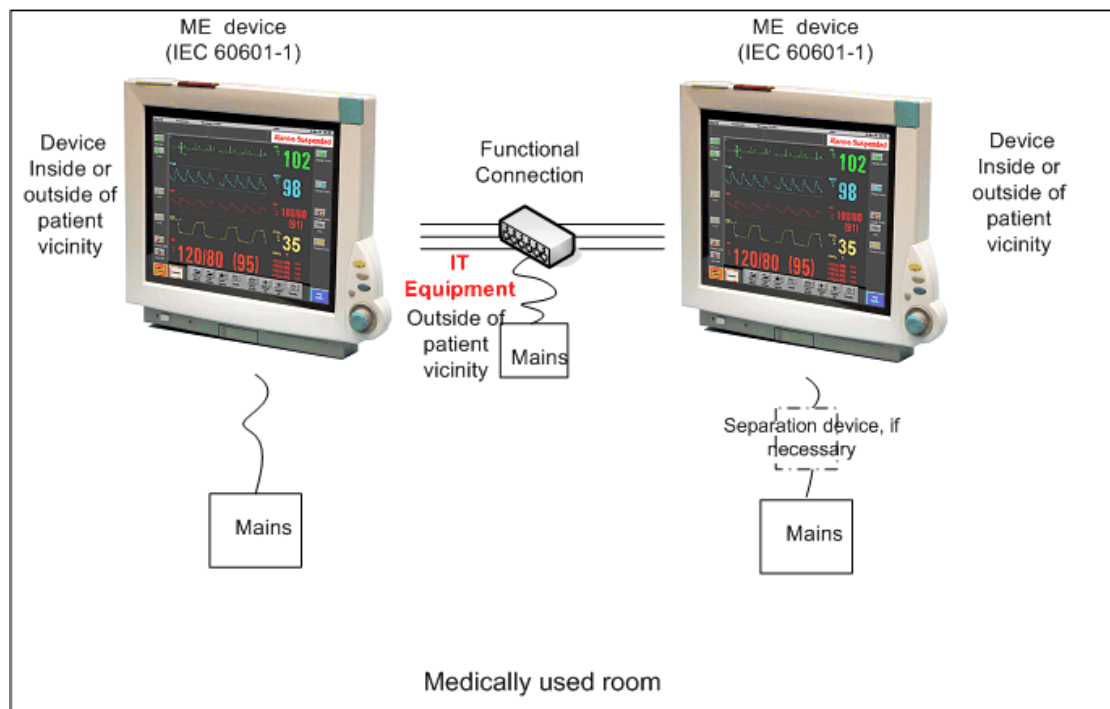



For any IT equipment (IEC60950) operated in patient vicinity ensure that the equipment leakage current does not exceed the limits described in IEC 60601-1. Use a separation device to ensure compliance. After installation of IT equipment in patient vicinity, an enclosure leakage current test is required.

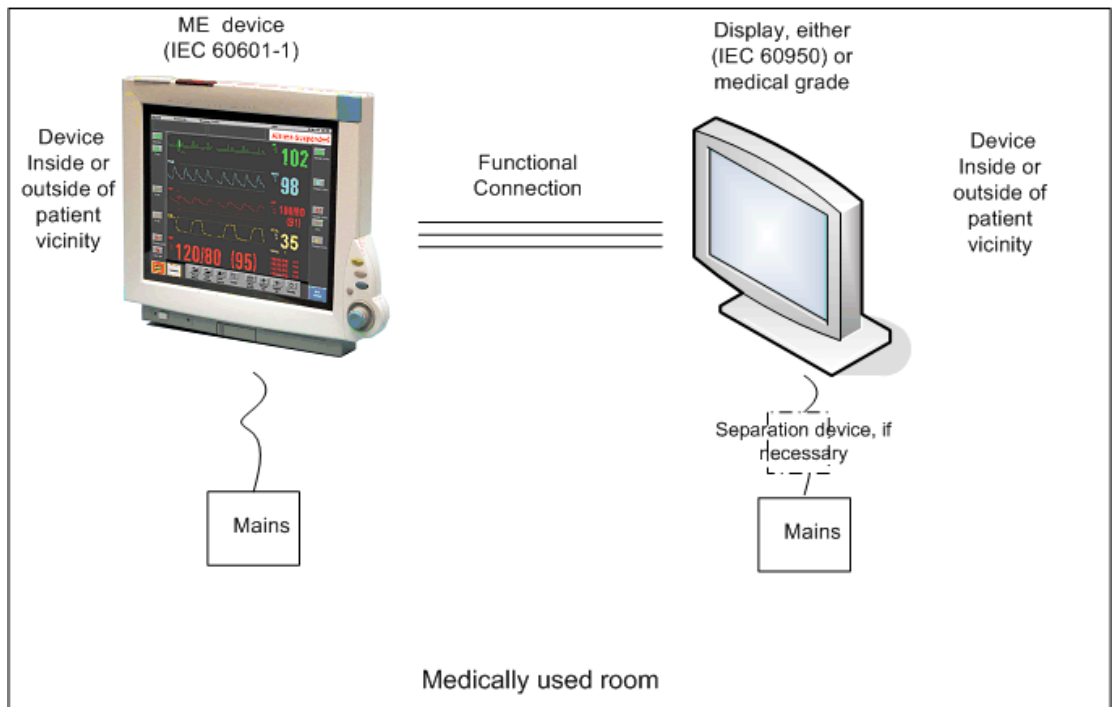
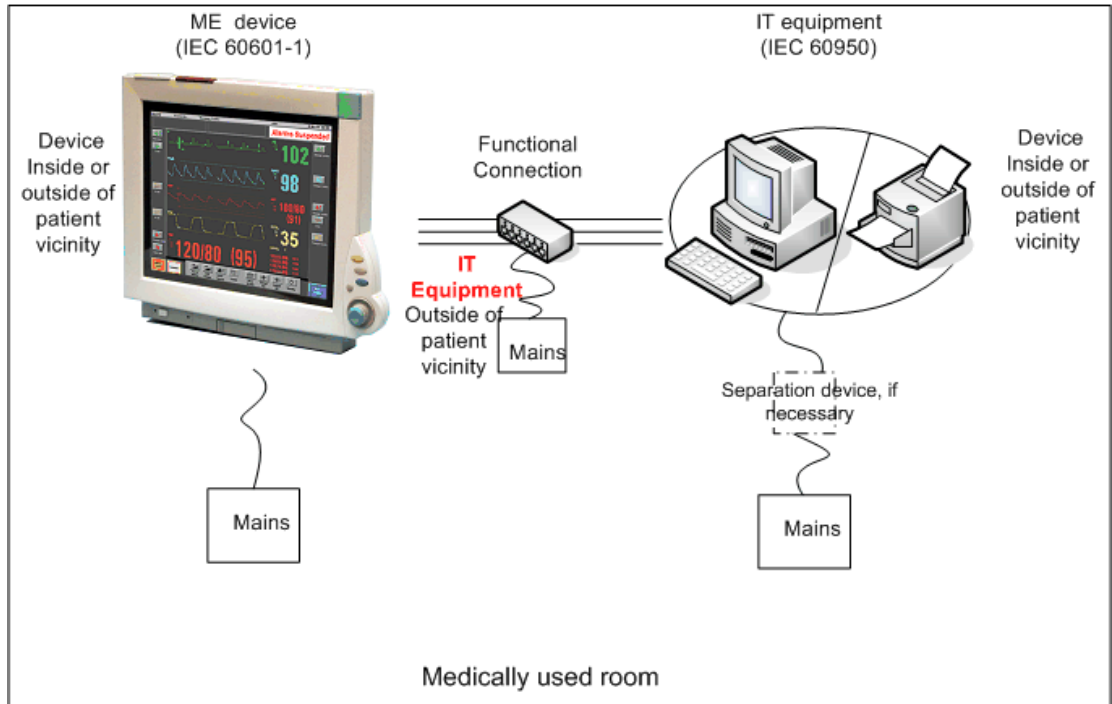

If the combined devices forming the medical electrical system are connected to the same multiple portable socket outlet, ensure that the resulting protective earth leakage current **and** equipment leakage current do not exceed the limits of IEC 60601-1-1. The medical electrical devices or IT equipment may be located in or outside the patient vicinity in a medically used room. Avoid using multiple portable socket outlets. If the limits of IEC 60601-1-1 are exceeded, additional protective measures are required, e.g. a separation device or the connection of each device to separate mains.

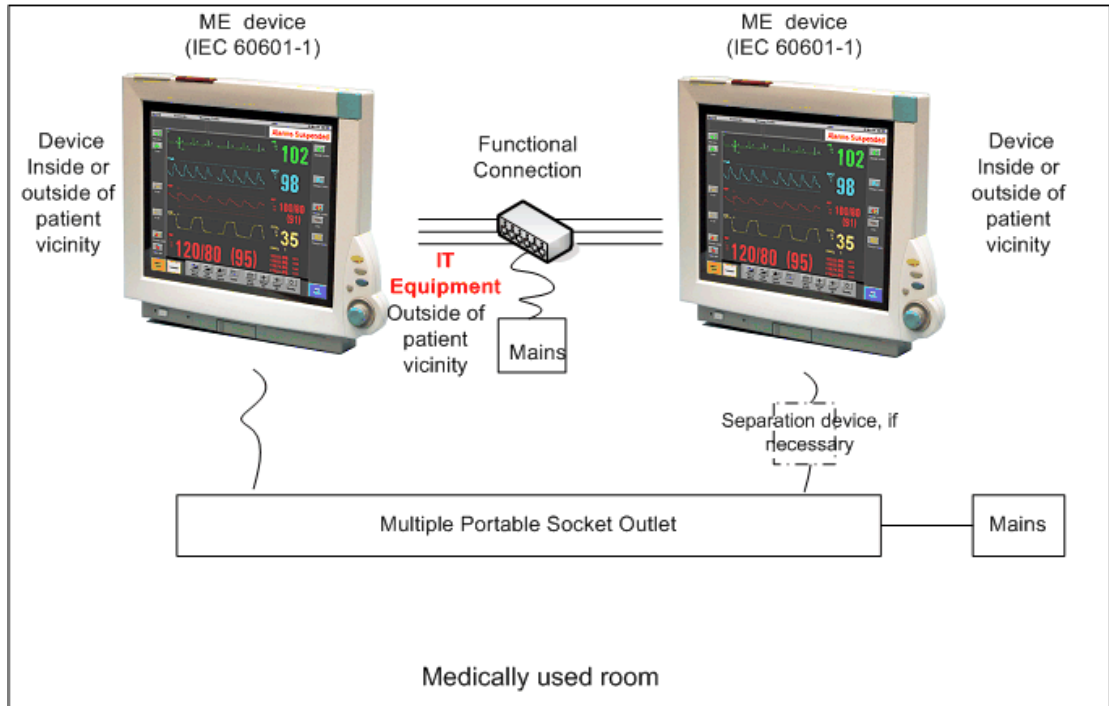

For any IT equipment (IEC60950) operated in patient vicinity ensure that the equipment leakage current does not exceed the limits described in IEC 60601-1. Use a separation device to ensure compliance. After installation of IT equipment in patient vicinity, an enclosure leakage current test is required.

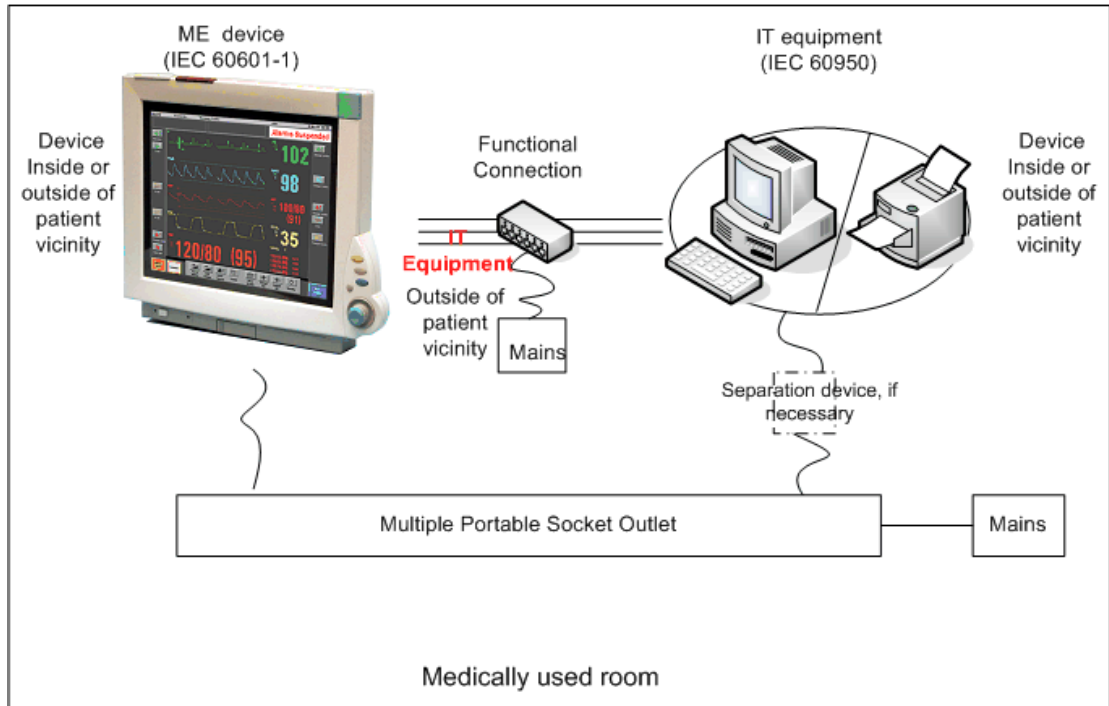

### Case 3: Medical Device Combined with a Medical or Non-Medical Device with one Device in a Non-Medically-Used Room

If you combine a medical device with a medical or non-medical device to form a medical electrical system according to IEC60601-1-1 using a common protective earth connection and one of the devices is located in a non-medically used room, additional protective measures are required, e.g. usage of a separation device or additional protective earth connection. The medical electrical devices or IT equipment may be located in or outside the patient vicinity. After system installation incl. protective measures, a system test is required to ensure that the resulting equipment leakage current does not exceed the limits of IEC 60601-1-1.

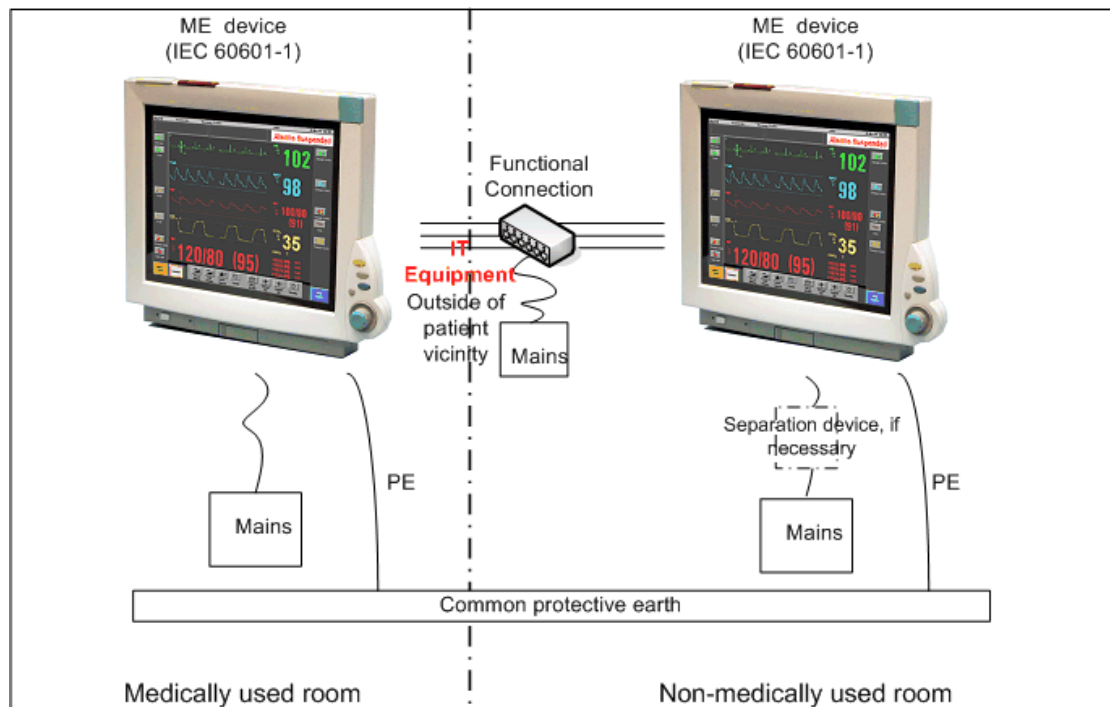

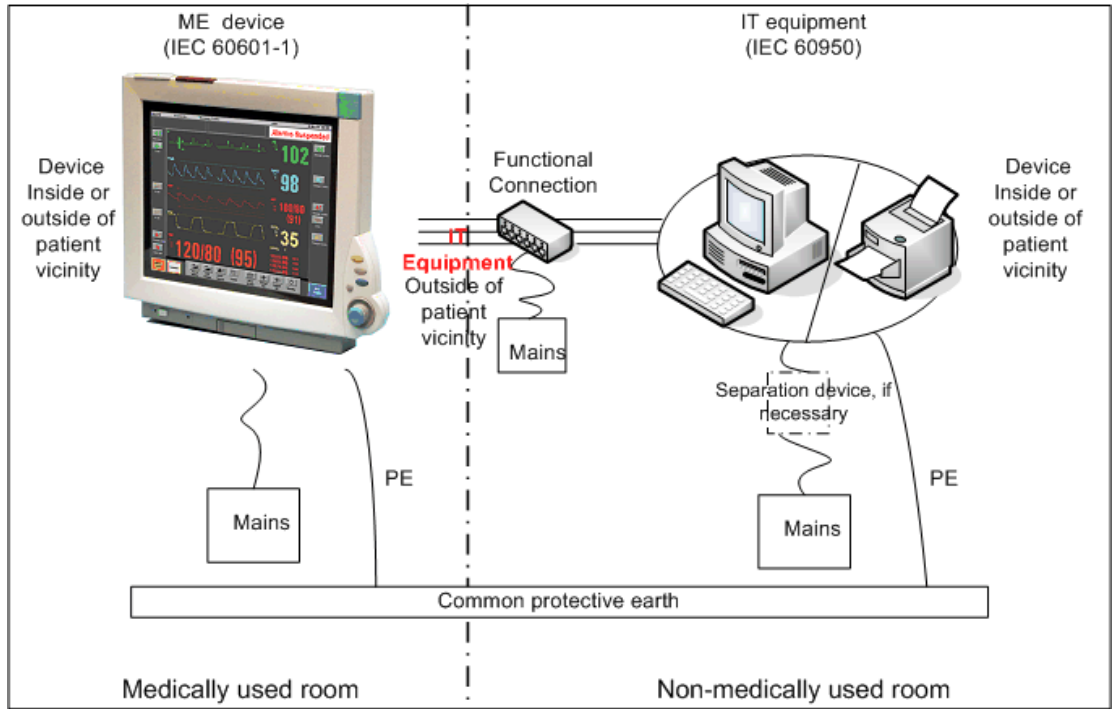

If you combine a medical device with a medical or non-medical device to form a medical electrical system according to IEC60601-1-1 using two separate protective earth connections and one of the devices is located in a non-medically used room creating a potential voltage difference, additional protective measures are required, e.g. usage of a separation device or additional protective earth connection. The medical electrical devices or IT equipment may be located in or outside the patient vicinity. After system installation incl. protective measures, a system test is required to ensure that the resulting equipment leakage current does not exceed the limits of IEC 60601-1-1.

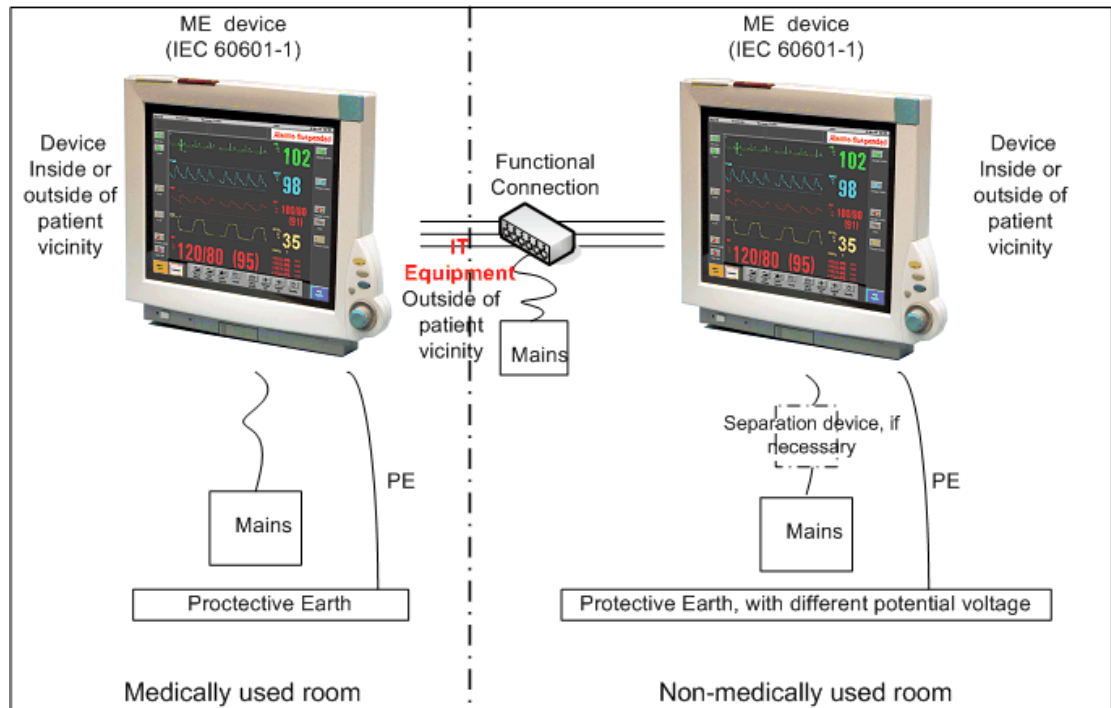

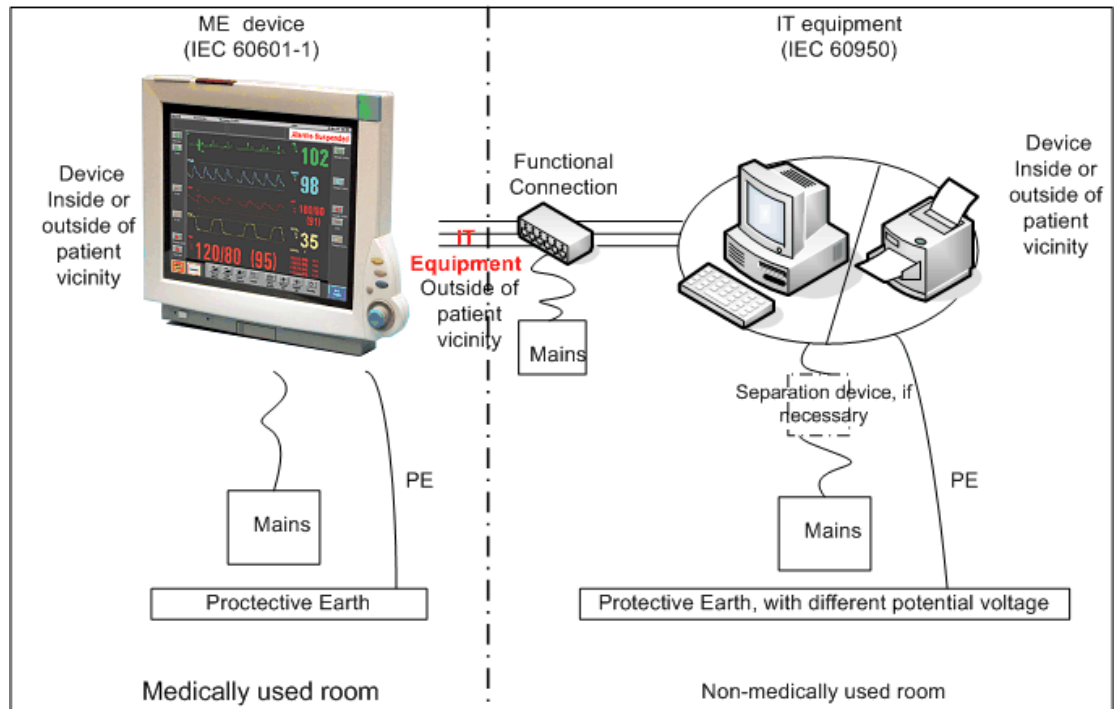

### System Test Procedure

If the medical electrical device has already been tested as a standalone device e.g. during factory safety testing, an equipment leakage current test must only be performed once the device is connected to the LAN network. If the medical electrical system has not been tested as a standalone device, the device has to be tested as a standalone device (without connection to the system) and as part of the system (with connection to the system).

Connect the detachable power cord of the device under test to the safety analyzer's test mains port. Connect the enclosure test lead of the safety analyzer to the enclosure of the device under test, e.g. to the equipotential connector. Refer to the documentation that accompanies the safety analyzer for further details on how to set up the test.

| Test  | Expected test results |
|---|-----------------------|
| Equipment Leakage Current Test (Normal Condition)       | Sys1 <= 100µA         |
| Equipment Leakage Current Test (Single Fault Condition) | Sys2 <= 300µA         |

After the testing of the device as a standalone device and as part of the system, check that the resulting values (without connection and with connection to the system) do not differ by more than +/- 10% from each other.

If the devices in the medical electrical system are connected to a multiple portable socket outlet the resulting protective earth leakage current needs to be determined. All system components must be connected to the multiple portable socket outlet and be switched on during this measurement.

| Test  | Expected test results |
|---|-----------------------|
| Protective Earth Leakage Current of Multiple Socket Outlets | Sys3 <= 300μA         |

Refer to the documentation that accompanies the safety analyzer for further details on how to set up the test.

## Preventive Maintenance Procedures

### Noninvasive Blood Pressure Measurement Calibration

Carry out the noninvasive blood pressure measurement performance tests at least every two years , or as specified by local laws (whichever comes first).

## Performance Assurance Tests

Some of the following test procedures must be performed in service mode. To enter service mode select **Operating Modes** in the main menu. Then select **Service Mode** and enter the password.

If required, open the screen menu in the monitor info line at the top of the screen and select **Service** to access the service screen. This is required particularly for Anesthetic Gas Module testing procedures.

### Basic Performance Assurance Test

This section describes the basic performance test procedure. Please refer to the section **When to Perform Tests** (on page 34) for detailed information on when which test procedure is required.

#### Procedure:

Power on the monitoring system and go into demo mode. Check that each parameter (incl. Gas Analyzer) displays values.



## Full Performance Assurance Test

The following sections describe the full performance testing procedures i.e. detailed testing of each parameter with a patient simulator or specified tools. Please refer to the section When to perform Tests for information on when which testing procedure is required.

### ECG/Resp Performance Test

This test checks the performance of the ECG and respiration measurements.

**Tools required:** Patient simulator.

#### ECG Performance

1. Connect the patient simulator to the ECG/Resp connector.
2. Configure the patient simulator as follows:
  - ECG sinus rhythm.
  - HR = 100 bpm or 120 bpm (depending on your patient simulator).
3. Check the displayed ECG wave and HR value against the simulator configuration.
4. The value should be 100bpm or 120 bpm +/- 2 bpm.

#### Respiration Performance

1. Change the Patient Simulator configuration to:
  - Base impedance line 1500 Ohm.
  - Delta impedance 0.5 Ohm.
  - Respiration rate 40 rpm or 45 rpm.
2. The value should be 40 rpm +/- 2 rpm or 45 rpm +/- 2 rpm.

| Test                         | Expected test results                   |
|------------------------------|---|
| ECG Performance Test         | 100bpm +/- 2bpm or<br>120bpm +/- 2bpm   |
| Respiration Performance Test | 40 rpm +/- 2 rpm or<br>45 rpm +/- 2 rpm |

## ECG Sync Performance Test

This test checks the performance of ECG synchronization between the monitor and a defibrillator. It only needs to be performed when this feature is in use as a protocol at the customer site.

### Tools required:

- Defibrillator with ECG Sync and Marker Output.
  - Patient simulator.
1. Connect the patient simulator to the ECG connector and the defibrillator to the ECG Sync Output on the monitor.
  2. Set the patient simulator to the following configuration:
    - HR = 100 bpm or 120 bpm (depending on your patient simulator).
    - ECG sinus rhythm.
  3. Switch the defibrillator to simulation mode.
  4. Check that the marker pulse is displayed before the T-wave begins.

| Test                      | Expected test results                              |
|---------------------------|--|
| ECG Sync Performance Test | Marker pulse is displayed before the T-wave begins |

## SpO2 Performance Test

This test checks the performance of the SpO2 measurement.

### Tools required: none

1. Connect an adult SpO2 transducer to the SpO2 connector.
2. Measure the SpO<sub>2</sub> value on your finger (this assumes that you are healthy).
3. The value should be between 95% and 100%.

| Test                  | Expected test results |
|-----------------------|-----------------------|
| SpO2 Performance Test | 95% and 100%          |

## Measurement Validation

The SpO<sub>2</sub> accuracy has been validated in human studies against arterial blood sample reference measured with a CO-oximeter. In a controlled desaturation study, healthy adult volunteers with saturation levels between 70% and 100% SaO<sub>2</sub> were studied. The population characteristics for those studies were:

- about 50% female and 50% male subjects
- age range: 18 to 45
- skin tone: from light to black

### NOTE

A functional tester cannot be used to assess the accuracy of a pulse oximeter monitor. However, it can be used to demonstrate that a particular pulse oximeter monitor reproduces a calibration curve that has been independently demonstrated to fulfill a particular accuracy specification.

## NBP Performance Test

This section describes NBP test procedures. The monitor must be in service mode and the screen “Service A” must be selected to perform these tests. The NBP Performance Test consists of:

- NBP Accuracy Test
- NBP Leakage Test
- NBP Linearity Test
- Valve Test

## NBP Accuracy Test

This test checks the performance of the non-invasive blood pressure measurement. Connect the equipment as shown:

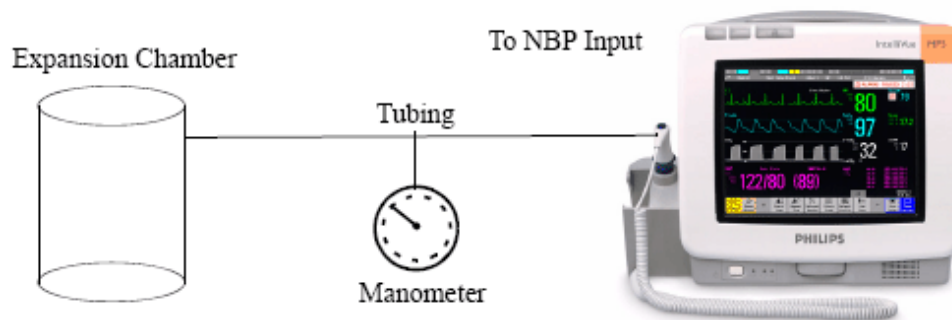

Tools required:

- Reference manometer (includes hand pump and valve), accuracy 0.2% of reading.
- Expansion chamber (volume 250 ml +/- 10%)
- Appropriate tubing.

In service mode, the systolic and diastolic readings indicate the noise of NBP channels 1 and 2 respectively. When static pressure is applied, the reading in NBP channel 1 should be below 50. The value in parentheses indicates the actual pressure applied to the system.

1. Connect the manometer and the pump with tubing to the NBP connector and to the expansion chamber.
2. In service mode, select the **Setup NBP** menu.
3. Select **Close Valves: On**
4. Raise the pressure to 280 mmHg with the manometer pump.
5. Wait 10 seconds for the measurement to stabilize.
6. Compare the manometer values with the displayed values.
7. Document the value displayed by the monitor (**x1**).
8. If the difference between the manometer and displayed values is greater than 3 mmHg, calibrate the MMS. If not, proceed to the leakage test.
9. To calibrate the MMS, select **Close Valves off** then **Calibrate NBP** and wait for the instrument to pump up the expansion chamber. Wait a few seconds after pumping stops until **EnterPrVal** is highlighted and then move the cursor to the value shown on the manometer. If one of the following prompt messages appears during this step, check whether there is leakage in the setup:
  - NBP unable to calibrate—cannot adjust pressure
  - NBP unable to calibrate—unstable signal
10. Press **Confirm**.

If the INOP NBP Equipment Malfunction message occurs in monitoring mode, go back to service mode and repeat the calibration procedure.

### NBP Leakage Test

The NBP leakage test checks the integrity of the system and of the valve. It is required once every two years and when you repair the monitor or replace parts.

1. If you have calibrated, repeat steps 2 to 6 from the accuracy test procedure so that you have 280 mmHg pressure on the expansion chamber.
2. Watch the pressure value for 60 seconds.
3. Calculate and document the leakage test value (**x2**).  

$$x2 = P1 - P2$$
 where P1 is the pressure at the beginning of the leakage test and P2 is the pressure displayed after 60 seconds.  
 The leakage test value should be less than 6 mmHg.

**NBP Linearity Test**

1. Reduce the manometer pressure to 150 mmHg.
2. Wait 10 seconds for the measurement to stabilize.
3. After these 10 seconds, compare the manometer value with the displayed value.
4. Document the value displayed by the monitor (x3)
5. If the difference is greater than 3 mmHg, calibrate the MMS (see steps 9 to 10 in the accuracy test procedure).

**Valve Test**

1. Raise the pressure again to 280 mmHg.
2. Select **Close valves: Off**.
3. Wait five seconds and then document the value displayed. The value should be less than 10 mmHg.
4. Document the value displayed by the monitor (x4).

**Expected Test Results for NBP Accuracy Test, Leakage Test, Linearity Test & Valve Test**

| Test           | Expected test results                                      |
|----------------|--|
| Accuracy test  | x1 = value displayed by monitor<br>Difference $\leq$ 3mmHg |
| Leakage test   | x2 = leakage test value<br>x2 < 6 mmHg                     |
| Linearity test | x3 = value displayed by monitor<br>Difference $\leq$ 3mmHg |
| Valve Test     | x4 = value < 10 mmHg                                       |

**Invasive Pressure Performance Test**

This test checks the performance of the invasive pressure measurement.

**Tools required:** Patient simulator.

1. Connect the patient simulator to the pressure connector.
2. Set the patient simulator to 0 pressure.
3. Make a zero calibration.
4. Configure the patient simulator as P(static) = 200 mmHg.
5. Wait for the display.

- The value should be  $200 \text{ mmHg} \pm 5 \text{ mmHg}$ . If the value is outside these tolerances, calibrate the Invasive Pressure measurement. If the measurement was calibrated with a dedicated reusable catheter, check the calibration together with this catheter.

**Table 4:**

| Test                               | Expected test results                 |
|------------------------------------|---------------------------------------|
| Invasive Pressure Performance Test | $200 \text{ mmHg} \pm 5 \text{ mmHg}$ |

### Temperature Performance Test

This test checks the performance of the temperature measurement.

Tools required: Patient simulator (with  $0.1^\circ\text{C}$  or  $0.2^\circ\text{F}$ ).

- Connect the patient simulator to the temperature connector.
- Configure the patient simulator to  $40^\circ\text{C}$  or  $100^\circ\text{F}$ .
- The value should be  $40^\circ\text{C} \pm 0.2^\circ\text{C}$  or  $100^\circ\text{F} \pm 0.4^\circ\text{F}$ .

**Table 2:**

| Test                         | Expected test results   |
|------------------------------|---|
| Temperature Performance Test | $40^\circ\text{C} \pm 0.2^\circ\text{C}$ or $100^\circ\text{F} \pm 0.4^\circ\text{F}$ |

### Mainstream CO<sub>2</sub> Accuracy Check

Tools Required:

- three airway adapters
- Verification Gas M2506A
- Gas cylinder regulator M2505A

You also need a local barometric pressure rating received from a reliable local source (airport, regional weather station or hospital weather station) which is located at the same altitude as the hospital.

#### Procedure:

- Attach the M2501A CO<sub>2</sub> sensor to the patient monitor. Attach an airway adapter to the sensor. Make sure that the sensor is disconnected from the patient circuit.
- Switch on the patient monitor.
- Enter the monitor's Service Mode.
- Using the sensor status provided in the M2501A Serial protocol, wait for the M2501A sensor to warm up to its operating temperature.
- The default setting for gas temperature is  $22^\circ\text{C}$ . If the gas temperature is significantly above or below this value, correct the gas temperature setting.

6. Zero the sensor on the airway adapter being used in this test. Ensure Zero Gas is set to Room Air
7. Attach a regulated flowing gas mixture of 5% CO<sub>2</sub>, balance N<sub>2</sub> to the airway adapter.
8. Set the gas correction to off.
9. Allow a few seconds for the gas mixture to stabilize and observe the CO<sub>2</sub> value. The expected value is 5% of the ambient pressure  $\pm 2$ mmHg

**NOTE**

Make sure that you follow the above steps correctly. If the sensor fails this check it must be exchanged. The sensor cannot be calibrated.

**Example for an expected test result:**

The expected test result for an altitude of 0 m (sea level) at approximately 760 mmHg ambient pressure is:

**Table 6:**

| Test                                     | Expected test results (x1)           | Acceptance Range  |
|--|--------------------------------------|-------------------|
| Mainstream CO <sub>2</sub> Accuracy Test | 5% of 760 mmHg pressure $\pm 2$ mmHg | 36 mmHg - 40 mmHg |

**NOTE**

The expected test results will differ depending on the conditions (i.e. altitude or ambient pressure).

**Sidestream CO<sub>2</sub> Accuracy Check**

Tools Required:

- Cal gas flow regulator M2267A
- Cal tube 13907A
- Verification Gas M2506A
- Straight Sample Line M2776A

You also need a local barometric pressure rating received from a reliable local source (airport, regional weather station or hospital weather station) which is located at the same altitude as the hospital.

**Procedure:**

1. Attach the M2741A CO<sub>2</sub> sensor to the patient monitor. Attach the sample line and the cal tube to the sensor. Make sure that the sensor is disconnected from the patient circuit.
2. Switch on the patient monitor.
3. Enter the monitor's Service Mode.
4. Using the sensor status provided in the M2741A Serial protocol, wait for the M2741A sensor to warm up to its operating temperature.
5. Zero the sensor. Ensure Zero Gas is set to Room Air
6. Attach a regulated flowing gas mixture of 5% CO<sub>2</sub>, balance N<sub>2</sub> to the cal tube.

7. Set the gas correction to off.
8. Allow a few seconds for the gas mixture to stabilize and observe the CO<sub>2</sub> value. The expected value is 5% of the ambient pressure  $\pm 2$ mmHg

**NOTE**

Make sure that you follow the above steps correctly. If the sensor fails this check it must be exchanged. The sensor cannot be calibrated

**Example for an expected test result:**

The expected test result for an altitude of 0 m (sea level) at approximately 760 mmHg ambient pressure is:

| <b>Test</b>                              | <b>Expected test results (x2)</b>    | <b>Acceptance Range</b> |
|--|--------------------------------------|-------------------------|
| Sidestream CO <sub>2</sub> Accuracy Test | 5% of 760 mmHg pressure $\pm 2$ mmHg | 36 mmHg - 40 mmHg       |

**NOTE**

The expected test results will differ depending on the conditions (i.e. altitude or ambient pressure).

**Sidestream CO<sub>2</sub> Flow Check**

Check the flow rate in the Sidestream CO<sub>2</sub> extension as follows:

1. Connect the flowmeter to the sample line
2. Check on the flowmeter the flow that the Sidestream CO<sub>2</sub> extension pump draws. It should be 50 ml/min  $\pm$  10 ml/min. If the value is not within tolerance check your setup again and perform another flow check. If it fails again, the sensor must be replaced. The sensor cannot be calibrated.



## Microstream CO<sub>2</sub> Performance Test

Allow five seconds between individual service procedures to ensure stable equipment conditions. When certain monitor procedures are running, service procedures are not possible and trying to start them will result in a message **Service Operation Failed** in the monitor's status line. Wait until the monitor completes the current operation, then restart the service procedure.

This test checks the performance of the Microstream CO<sub>2</sub> measurement. The Microstream CO<sub>2</sub> measurement can either be integrated into the IntelliVue MP5 monitor or, for other IntelliVue monitors, into the M3015A MMS Extension. The Microstream CO<sub>2</sub> performance test is required once per year and when the instrument is repaired or when parts are replaced.

This test uses calibration equipment that you can order (see the *Parts* section for the part number). The procedure is summarized in the following steps. Refer to the documentation accompanying the equipment for detailed instructions.

Tools Required:

- Standard tools, such as screwdriver, tweezers
- Electronic flowmeter, M1026-60144
- Gas calibration equipment:
  - Cal 1 gas 15210-64010 (5% CO<sub>2</sub>)
  - Cal 2 gas 15210-64020 (10% CO<sub>2</sub>)
  - Cal gas flow regulator M2267A
  - Cal tube 13907A
  - Calibration Line M3015-47301

You also need a local barometric pressure rating received from a reliable local source (airport, regional weather station or hospital weather station) which is located at the same altitude as the hospital.

The CO<sub>2</sub> calibration for the Microstream extension consists of the following steps:

- Leakage check
- Barometric pressure check and calibration, if required.
- Pump check
- Flow check and calibration, if required
- Noise check
- CO<sub>2</sub> Cal check and calibration, if required
- CO<sub>2</sub> Cal verification using 2nd cal gas

Perform all checks in the same session.

## Leakage Check

The leakage check consists of checking the tubing between:

- the pump outlet and the mCO<sub>2</sub> outlet and
- the pump inlet and FilterLine inlet.

Check the user's guide of the flowmeter for details on how to make a correct flow reading.

### Part 1

1. Go into service mode and select **Setup CO2** menu.
2. Connect a FilterLine to the Microstream CO<sub>2</sub> input to start the pump running.
3. Check the ambient pressure and the cell pressure shown in the monitor's status line. The cell pressure should be approximately 20 mmHg lower than ambient pressure.
4. Connect the flowmeter outlet to the FilterLine inlet using a flexible connecting tube.
5. Block the mCO<sub>2</sub> outlet using your fingertip and observe the flowmeter display. The value on the flowmeter (**x1**) should decrease to between 0 and 4 ml/min, accompanied by an audible increase in pump noise. If the value is within the tolerance limits, continue with part 2 of the leakage check.
6. If the value is outside the tolerance limits, there is a leakage between the pump outlet and the mCO<sub>2</sub> outlet.
7. Open the MMS Extension or MP5 and check the tubing connections at the pump outlet and the extension gas outlet. If the connections are good, then there is a leakage in the tubing and you must exchange the MMS Extension or the mCO<sub>2</sub> Assembly of the MP5 respectively.

### Part 2

1. Disconnect the flowmeter from the Part 1 setup and connect the flowmeter inlet to the M3015A gas outlet or the MP5 mCO<sub>2</sub> gas outlet.
2. Leave the Filterline connected to the M3015A inlet or the MP5 mCO<sub>2</sub> inlet..
3. Block the inlet of the FilterLine using your fingertip and observe the flowmeter display. The value on the flowmeter (**x2**) should decrease to between 0 and 4 ml/min, accompanied by an audible increase in pump noise. The cell pressure shown in the status line on the display should decrease to between 300 and 500 mmHg. Do not block the inlet for longer than 25 seconds as this will lead to an "Occlusion" INOP. If the value is within the tolerance limits, there are no leakages and the leakage check is completed; proceed to the pump check.
4. If the value is not within the tolerance limits, there is a leakage between the FilterLine inlet and the pump inlet.
5. Check the FilterLine connections and open the M3015A or MP5 to check the tubing connections at the pump inlet and the M3015A or MP5 mCO<sub>2</sub> gas inlet. If the connections are good, try replacing the FilterLine and repeating the leakage check. If the situation remains, there is a leakage in the tubing and the M3015A or the mCO<sub>2</sub> assembly of the MP5 must be exchanged.

### Barometric Pressure Check and Calibration

Check the barometric pressure value in the M3015A MMS Extension or the MP5 as follows:

1. Go into service mode and select **Setup CO<sub>2</sub>** menu.
2. Connect a FilterLine to the Microstream CO<sub>2</sub> input. This activates the pump in the M3015A MMS Extension or the MP5.
3. The status line at the bottom of the screen displays “CO<sub>2</sub> pressure reading (ambient/cell) xxx/yyy” where xxx is the ambient pressure and yyy is the measured cell pressure. Check whether the ambient pressure value (**x3**) matches (within the acceptable tolerance of  $\pm 12$  mm Hg) the reference value you have received. If so, proceed to the leakage check. If the value is not correct, calibrate as follows.
  - a. Select **CO<sub>2</sub>** then select **Barom. Press** to activate a table of values.
  - b. Select the value in the table which matches the reference value received from a reliable local source (airport, regional weather station or hospital weather station). (The values are displayed with a resolution of 2 mmHg up to 500 mmHg and a resolution of 1 mmHg from 500 mmHg to 825 mmHg.) Note: the selected value must be within  $\pm 10\%$  of the current measured ambient pressure, otherwise an error message will occur at restarting the monitor.
  - c. Confirm the barometric pressure setting.
  - d. Check that the ambient pressure displayed in the status line at the bottom of the screen is the same as the value which you selected from the list in step b.

### Pump Check

1. Connect the flowmeter inlet to the mCO<sub>2</sub> gas outlet.
2. Connect the FilterLine to the mCO<sub>2</sub> inlet.
3. Block the inlet of the FilterLine using your fingertip and observe the cell pressure on the monitor display. The cell pressure (**x4**) should be more than 120 mmHg below the ambient pressure shown. If the pressure difference is less than 120 mmHg, the pump is not strong enough and you should replace it, irrespective of the Pump OpTime.

### Flow Rate Check and Calibration

Check the flow rate in the M3015A MMS Extension or the MP5 as follows:

1. Connect the flowmeter to the CO<sub>2</sub> FilterLine.
2. Check on the flowmeter the flow that the M3015A MMS Extension or MP5 mCO<sub>2</sub> pump draws (**x5**). It should be 50 ml/min  $\pm$  7.5 ml/min. If the value is within tolerance, proceed to the CO<sub>2</sub> Gas calibration check. If the value is not within tolerance, calibrate as follows.
3. Adjust the flow in the instrument by selecting **Increase Flow** or **Decrease Flow** until it is as close as possible to 50 ml per minute as indicated on the flowmeter gauge.
4. When you are satisfied that the flow is set as close as possible to 50 ml per minute, select **Store Flow** and confirm the setting. If you do not store the adjusted flow within 60 seconds of the adjustment, the old flow setting is restored.

5. If you cannot adjust the flow to within tolerance, replace the pump . If you still cannot make the flow adjustment, this indicates a fault in the measurement extension, which must be replaced.

Note that the pump can only be replaced on M3015A with the old hardware Rev. A (i.e. Serial No. DE020xxxxx)

### Noise Check

1. With the monitor in service mode, select **Setup CO<sub>2</sub>** menu.
2. Disconnect the flowmeter and connect the 5% calibration gas and flow regulator in its place.
3. Open the valve to apply the 5% calibration gas and wait until the value is stable.
4. Check the noise index (**x6**) displayed next to the CO<sub>2</sub> value on the display (this indicates the level of noise on the CO<sub>2</sub> wave). If the value exceeds 3 mmHg, replace the measurement extension.

### CO<sub>2</sub> Gas Measurement Calibration Check

After switching the measurement extension on, wait at least 20 minutes before checking the calibration. Check the calibration of the CO<sub>2</sub> gas measurement as follows:

1. Check that the 5% calibration gas and flow regulator are connected.
2. Calculate the expected measurement value in mmHg as follows:  
 $0.05 \times (\text{ambient pressure}) = \text{value mmHg}$   
 for example  $0.05 \times 736 = 36.8 \text{ mmHg}$  (with an ambient pressure of 736 mmHg)
3. Open the valve on the flow regulator to allow 5% CO<sub>2</sub> gas to flow into the extension. Allow the value to stabilize.
4. Check that the value on the instrument (measurement value on the main screen, **x7**) matches the calculated mmHg value  $\pm 2.6 \text{ mmHg}$ . If the value is outside the tolerance, calibrate as described in step 1 in this procedure onwards.
5. Disconnect the 5% calibration gas and connect the 10% calibration gas.
6. Calculate the expected measurement value and tolerance in mmHg as follows:  
 $0.1 \times (\text{ambient pressure}) = \text{value mmHg}$   
 $\pm 0.07 \times (\text{value mmHg}) = \text{tolerance}$   
 for example  $0.1 \times 737 \text{ mmHg} = 73.7 \text{ mmHg}$  (with an ambient pressure of 737 mmHg)  
 $\pm 0.07 \times 73.7 \text{ mmHg} = \pm 5.16 \text{ mmHg}$  tolerance
7. Open the valve on the flow regulator to allow 10% CO<sub>2</sub> gas to flow into the extension. Allow the value to stabilize.
8. Check that the value on the instrument (**x8**) matches the calculated mmHg value within the calculated tolerance. If so, the measurement extension is correctly calibrated. If the value is outside the tolerance, calibrate as follows.
9. If not already connected, connect the 5% calibration gas.
10. Select **Cal. CO<sub>2</sub>**.
11. Select the value for the calibration gas. (The default value is 5.0%.)

12. Open the valve on the calibration gas to allow CO<sub>2</sub> gas to flow into the extension. Allow the value to stabilize before the start of the calibration. Leave the valve open until the instrument gives a prompt that gas can be removed.
13. The extension calibrates and prompts when calibration is successful.

### Calibration Verification

1. Reopen the 5% gas valve and allow the value to stabilize.
2. Check that the value displayed on the monitor is correct within the tolerance (see step above).
3. Disconnect the 5% calibration gas and connect the 10% calibration gas.
4. Open the valve on the flow regulator to allow 10% CO<sub>2</sub> gas to flow into the extension. Allow the value to stabilize.
5. Check that the value displayed on the monitor is correct within the tolerance (see step above).

If one or both values are not within tolerances, you must exchange the M3015A MMS Extension or the MP5 mCO<sub>2</sub> Assembly.

| Test                                  | Expected Test Results   |
|---------------------------------------|---|
| Leakage Check parts 1 and 2           | <b>x1</b> = value of part 1 leakage check on flowmeter ( <b>x1</b> < 4.0 ml/min)<br><b>x2</b> = value of part 2 leakage check on flowmeter ( <b>x2</b> < 4.0 ml/min)  |
| Barometric Pressure Check             | <b>x3</b> = difference between the reference pressure and the measured ambient pressure displayed on the monitor ( <b>x3</b> < 12 mmHg)                               |
| Pump Check                            | <b>x4</b> = difference in pressure between cell pressure and ambient pressure displayed on the monitor during occlusion ( <b>x4</b> > 120 mmHg)                       |
| Flow Check                            | <b>x5</b> = difference between measured value and 50.0 ml/min ( <b>x5</b> < 7.5 ml/min)   |
| Noise Check                           | <b>x6</b> = noise index displayed on monitor ( <b>x6</b> < 3.0)   |
| CO <sub>2</sub> Gas Calibration Check | <b>x7</b> = difference between measured CO <sub>2</sub> value and calculated value, based on 5% CO <sub>2</sub> cal. gas. ( <b>x7</b> < 2.6 mmHg)                     |
| CO <sub>2</sub> Cal Verification      | <b>x8</b> = difference between measured CO <sub>2</sub> value and calculated value, based on 10% CO <sub>2</sub> cal. gas. ( <b>x8</b> < ± {0.07 x value calculated}) |

## Reset Time Counters

### NOTE

This procedure only applies to M3015A with the old hardware Rev. A (i.e. Serial No. DE020xxxxx)

You must check the time counters on the Microstream CO<sub>2</sub> extension before calibrating the instrument. As well, when parts are replaced, the appropriate counters must be reset to zero.

The counters for CO<sub>2</sub> pump, IR Src and Last Cal are displayed in the status line. The values are updated when entering the **Setup CO2** menu.

Observe the following guidelines:

- When calibrating the CO<sub>2</sub> extension, if no parts have been replaced, check the displayed values of **Reset PumpOpTime** and **Reset IRSourceTime** selections to make sure that they are within suggested guidelines for use (15,000 hours of continuous use). If the counter time is greater than 15,000 hours, replace the appropriate part. See *Repair and Disassembly* for details.
- When calibrating the CO<sub>2</sub> extension, if parts have been replaced, reset the appropriate values using the **Reset PumpOpTime** and **Reset IRSourceTime** selections. See *Repair and Disassembly* for details.

Resetting the PumpOpTime generates the INOP: “CO<sub>2</sub> OCCLUSION”. To clear this INOP you must perform a flow check and store the flow in service mode (select **Store Flow**).

## Nurse Call Relay Performance Test

The nurse call relay performance test can be performed either at the phone jack type connector (this only tests one relay) or at the multi-port nurse call connector (to test all three relays).

### Phone Jack Type Connector Test (Traditional Nurse Call)

This test checks the operation of the traditional Nurse Call Relay. The Nurse Call Relay test is recommended for customer sites where the nurse call is in use. The Nurse Call relay functions as follows:

- Standard Operation—Relay open.
- Alarm Condition—Relay closed.

**Tools required:** Ohmmeter.

1. Plug a phono connector into the Nurse Call Relay connector.
2. Connect the ohmmeter.

- If no alarm occurs, the relay contacts are open. When an alarm occurs, the relay contacts close.

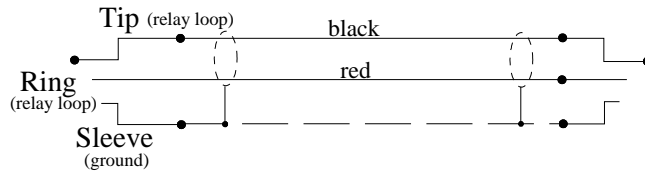

- The expected test result is: Alarm condition - Relay closed.

| Test                              | Expected test results        |
|-----------------------------------|------------------------------|
| Nurse Call Relay Performance Test | Alarm Condition—Relay closed |

### Modified MP5 Nurse Call Alarm Relay Test

Some customers may have an Open-On-Alarm relay instead of a Closed-On-Alarm for their Nursecall system.

The modified Nurse Call relay functions as follows:

- Standard Operation—Relay closed.
- Alarm Condition—Relay open.

**Tools required:** Ohmmeter.

- Plug a phono connector into the Nurse Call Relay connector.
- Connect the ohmmeter and verify the above conditions.
- If no alarm occurs, the relay contacts are closed. When an alarm occurs, the relay contacts open.

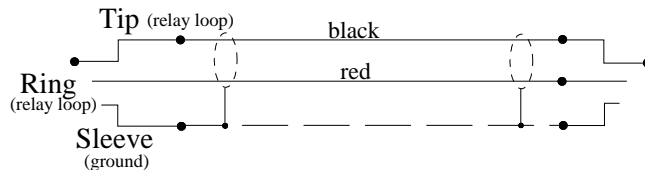

- The expected test result is: **Alarm Condition - Relay open.**

| Test                              | Expected test results      |
|-----------------------------------|----------------------------|
| Nurse Call Relay Performance Test | Alarm Condition—Relay open |

### Power Loss Alarm Buzzer Performance Test (only if Multi-Port Nurse Call Connector Board is installed)

1. Switch on the monitor.
2. Remove the battery and disconnect the monitor from AC power.
3. The Power Loss Alarm Buzzer should beep for about one minute.
4. To switch off the alarm sound, either press the power button, connect the monitor to AC power or insert a battery

| Test                                     | Expected test results |
|--|-----------------------|
| Power Loss Alarm Buzzer Performance Test | Beep for one minute   |

### IntelliVue 802.11 Bedside Adapter Communication Test

1. Make sure the LAN cable is disconnected from the rear of the monitor, then switch on the monitor.
2. Go into Service Mode and select **Main Setup -> Network -> Setup WLAN**. In the **Setup WLAN** menu:
  - set **Mode** to either **802.11Ah**, **802.11G**, **802.11Bg** (not recommended), **Auto** (not recommended) or **None** (this setting disables the wireless LAN functionality permanently), to match your wireless infrastructure installation.
  - set **SSID** to match your installation.
  - set the **Country** code to "1000". Setting the country code to this value will automatically adjust the regulatory domain to match the configuration of the infrastructure. Do not set the country code to values other than "1000" unless otherwise instructed.
  - set the **Security Mode** to **WPA(PSK)** and enter the **WPA password** (string between 8 and 63 characters).
3. Select **Main Setup -> WLAN Diagnostic** to access the service window.
4. Proper installation of the IntelliVue 802.11 Bedside Adapter is assured by connecting to an access point over the wireless link. Place the monitor with the IntelliVue 802.11 Bedside Adapter installed in close proximity to the access point (e.g. if the access point is mounted on the ceiling, place the monitor directly below). Wait until the **Conn. Status** field in the service window shows *Authenticated* (for Rel. C.0 monitors) or *Connected* (for Rel D.0 or higher). Take the monitor approximately 5 m away from the access point. There should be no walls or other obstacles between the monitor and the access point. The following should apply:



- Observe the **RSSI** (Received Signal Strength Indicator) value for at least 5 - 10 seconds. The **RSSI** value will fluctuate but should stay above 30 in a 5 m distance from the access point used. The wireless link should be active, i.e. the **Conn. Status** field should be *Authenticated* (for Rel. C.0 monitors) or *Connected* (for Rel D.0 or higher), and the other fields should contain values. If the **RSSI** value is significantly lower, check the distance to the access point and the antenna orientation at the monitor. The antenna orientation should be vertical, but the physical placement of the monitor or other equipment within its vicinity as well as walls or other obstacles may influence the antenna orientation required to receive the best RSSI value.
5. If this test fails, retry in a different physical area with a different access point.
  6. Perform the Wireless Switch test blocks as described in the Philips IntelliVue 802.11 a/g Infrastructure Installation and Configuration Guide.

| Test   | Expected test results |
|--|-----------------------|
| IntelliVue 802.11 Bedside Adapter Performance Test | RSSI value above 30   |

## IIT Communication Test

1. Make sure the LAN cable is disconnected from the external power supply of the monitor, then switch on the monitor.
2. Go into Configuration mode and, in the **Network** menu, set the **RF Access Code** in each profile to match your installation.
3. Go into Service Mode. Select **Main Setup** -> **Instr. Telemetry** to access the Instrument Telemetry Service window.
4. Proper installation of the IIT module is assured by connecting to an access point over the wireless link. Place the monitor with the IIT module installed in close proximity to the access point (e.g. if the access point is mounted on the ceiling, place the monitor directly below). Wait until the **Conn. Status** field in the Instrument Telemetry Service window shows *Active*. Take the monitor approximately 5 m away from the access point. There should be no walls or other obstacles between the monitor and the access point. The following should apply:
  - Observe the **RSSI** (Received Signal Strength Indicator) value for at least 5 - 10 seconds. The **RSSI** value should be around  $-50 \pm 10$  in a 5 m distance from the access point used and the IIT link should be active, i.e. the **Conn. Status** field should be *Active* and the other fields should contain values. If the **RSSI** value is significantly lower, check the distance to the access point and the antenna orientation at both the monitor and the access point (both should be vertical).
5. If this test fails, retry in a different physical area with a different access point.

### Error Conditions:

- The field **MAC Instr. Tele** should show a value **unequal to** 0000 0000 0000. If it does not, there is a communication problem between the monitor and the IIT adapter.

- With an incorrect RF Access Code or an incorrect or defective antenna installation, the fields **IP Address**, **Server IP**, **Subnet Mask**, and **RSSI** in the Instrument Telemetry Service window will stay blank. The field **Conn. Status** will slowly toggle between *Inactive* and *Seeking*.
6. Perform the Access Point Controller (APC) test blocks as described in the Philips IntelliVue Wireless Network Installation and Configuration Guide.

### Short Range Radio (SRR) Performance Test

1. Make sure that the short range radio interface is configured as follows: **SRR On** and appropriate channel selected.
2. Assign a telemetry transceiver to the IntelliVue Monitor according to the procedure described in the Instructions for Use of the patient monitor.
3. Check that the following conditions are fulfilled:
  - a. Place the telemetry transceiver close to the monitor.
  - b. The telemetry transceiver status is displayed on the monitor in the measurement selection window.
  - c. Waves or numerics from the telemetry transceiver are displayed on the monitor. There are no dropouts or gaps in waves or numeric transmission.
  - d. The battery status of the telemetry transceiver is displayed in the measurement selection window.
  - e. The Signal Quality Indicator shows at least 
4. Check that the data from the telemetry transceiver is transmitted to the monitor within a 1m radius and that there are no dropouts or gaps in waves or numerics.
5. Check whether the connection remains stable within a 5m radius from the monitor.
6. Switch on all telemetry transceivers used on the site and check that there are no interferences between the transceivers and their assigned monitors.
7. Check and record the coverage area of the telemetry transceivers and inform the customer about this coverage area.

## Reporting of Test Results

Philips recommends all test results are documented in accordance with local laws. Authorized Philips personnel report test result back to Philips to add to the product development database. While hospital personnel (biomedical engineers or technicians) do not need to report results to Philips, Philips recommends that they record and store the test results in accordance with local laws.

The following table lists what to record after completing the tests in this chapter. Record the results in the empty column in Table 16.

The following is a guide as to what your documentation should include:

- Identification of the testing body (for example, which company or department carried out the tests).
- Name of the person(s) who performed the tests and the concluding evaluation.
- Identification of the device(s) and accessories being tested (serial number, etc.).
- The actual tests (incl. visual inspections, performance tests, safety and system tests) and measurements required
- Date of testing and of the concluding evaluation.
- A record of the actual values of the test results, and whether these values passed or failed the tests.
- Date and confirmation of the person who performed the tests and evaluation.

The device under test should be marked according to the test result: passed or failed.

### Carrying Out and Reporting Tests

#### Test Report

|   |   |
|---|---|
| Testing Organization:<br>Name of testing person:        | Test before putting into service (reference value)<br>Recurrent Test<br><br>Test after Repair |
| Responsible Organization:                               |   |
| Device Under Test:                                      | ID-Number   |
| Product Number:   | Serial No.:   |
| Accessories:  |   |
| Measurement Equipment (Manufacturer, Type, Serial No.): |   |
| Functional Test (parameters tested):                    |   |

## Test and Inspection Matrix

| Test   | Test or Inspection to be Performed                                     | Expected Test Results   | Record the Results (mandatory for Philips Personnel only) |                |
|--|--|---|---|----------------|
|  |  |   | What to record  | Actual Results |
| Visual Inspection                            | Perform Visual Inspection  | Pass or Fail  | V:P or V:F  |                |
| Power On                                     | Power on the unit. Does the self-test complete successfully            | If Yes, Power On test is passed                                       | PO:P or PO:F  |                |
| Noninvasive Blood Pressure Performance Tests | Perform the Accuracy Test  | X1 = value displayed by monitor<br>Difference $\leq$ 3mmHg            | PN:P/X1 or<br>PN:F/X1                                     |                |
|  | Performance Leakage Test   | X2 = leakage test value<br>X2 < 6 mmHg                                | PN:P/X2 or<br>PN:F/X2                                     |                |
|  | Performance Linearity Test   | X3 = value displayed by monitor<br>Difference $\leq$ 3mmHg            | PN:P/X3 or<br>PN:F/X3                                     |                |
|  | Performance Valve Test   | X4 = value < 10 mmHg  | PN:P/X4 or<br>PN:F/X4                                     |                |
| Temperature Performance Test                 | Perform the Temperature Performance Test                               | X1= 40°C $\pm$ 0.2°C or 100°F $\pm$ 0.4°F                             | PT: P/X1 or<br>PT: F/X1                                   |                |
| All other performance tests                  | Perform the remaining parameter performance tests, if applicable       | See expected results in test procedures                               | P: P or<br>P: F   |                |
| Safety (1)                                   | Perform Safety Test (1): Protective Earth Resistance                   | With mains cable:<br>Maximum impedance (X1):<br>$\leq$ 300 mOhms      | S(1):P/X1 or<br>S(1):F/X1                                 |                |
| Safety (2)                                   | Perform Safety Test (2): Equipment Leakage Current - Normal Condition. | With mains cable:<br>Maximum leakage current (X1): $\leq$ 100 $\mu$ A | S(2): P/X1 or<br>S(2): F/X1                               |                |

| Test  | Test or Inspection to be Performed   | Expected Test Results  | Record the Results (mandatory for Philips Personnel only) |                |
|---|--|--|---|----------------|
|   |  |  | What to record  | Actual Results |
| Safety (3)  | Perform Safety Test (3): Equipment Leakage Current - Single Fault Condition (Open Earth)                         | With mains cable:<br>Maximum leakage current (X2): $\leq 300 \mu\text{A}$  | S(3): P/X2 or<br>S(3): F/X2                               |                |
| Safety (4)  | Perform Safety Test (4): Patient Leakage Current - Single Fault Condition, mains on applied part.                | Maximum leakage current (X1): $\leq 50 \mu\text{A}$  | S(4): P/X1 or<br>S(4): F/X1                               |                |
| System (Sys 1-2)  | Perform the system test according to subclause 19.201 of IEC/EN 60601-1-1, if applicable, after forming a system | Equipment Leakage Current:<br>Sys1 $\leq 100 \mu\text{A}$ (Normal Condition)<br>Sys2 $\leq 300 \mu\text{A}$ (Single Fault Condition)                               | Sys: PSys1/PSys2<br>or<br>Sys: FSys1/FSys2                |                |
| System (Sys 3)  | Perform the system test according to subclause 19.201 of IEC/EN 60601-1-1, if applicable, after forming a system | Protective Earth Leakage Current if medical electrical system components are connected to the same Multiple Portable Socket Outlet:<br>Sys3 $\leq 300 \mu\text{A}$ | Sys: PSys3<br>or<br>Sys: FSys3                            |                |
| Key: P = Pass, F = Fail, X or Sys = test value to be recorded |  |  |   |                |

**NOTE**

All values for current and voltage are the root mean square (r.m.s.) values, unless otherwise stated.

**Evaluation**

|   | Yes | No |
|---|-----|----|
| Safety and Functional Test passed                                   |     |    |
| Repair required at a later date, safety and functional test passed  |     |    |
| Device must be taken out of operation until repair and passed tests |     |    |
| Device failed and must be taken out of operation.                   |     |    |

**Notes:****Next Recurrent Test:****Name:** \_\_\_\_\_**Date/Signature:** \_\_\_\_\_**Evaluation of Test Results**

The evaluation of the test results must be performed by appropriately trained personnel with sufficient product, safety testing and application knowledge.

If any test results are between 90% and 100% of the respective expected result, the previously measured reference values must be taken into consideration for the assessment of the electrical safety of the device under test. If no reference values are available, you should consider shorter intervals between upcoming recurrent tests.

**NOTE**

If any single test fails, testing must be discontinued immediately and the device under test must be repaired or labeled as defective. Be sure to inform the user about the test failure in writing.

## Other Regular Tests

The care and cleaning requirements that apply to the monitor and its accessories are described in the Instructions for Use. This section details periodic maintenance procedures recommended for the monitor and its accessories.

## Touchscreen Calibration

To access the touchscreen calibration screen:

1. Enter service mode
2. Select **Main Setup**
3. Select **Hardware**
4. Select **Touch Calibration**

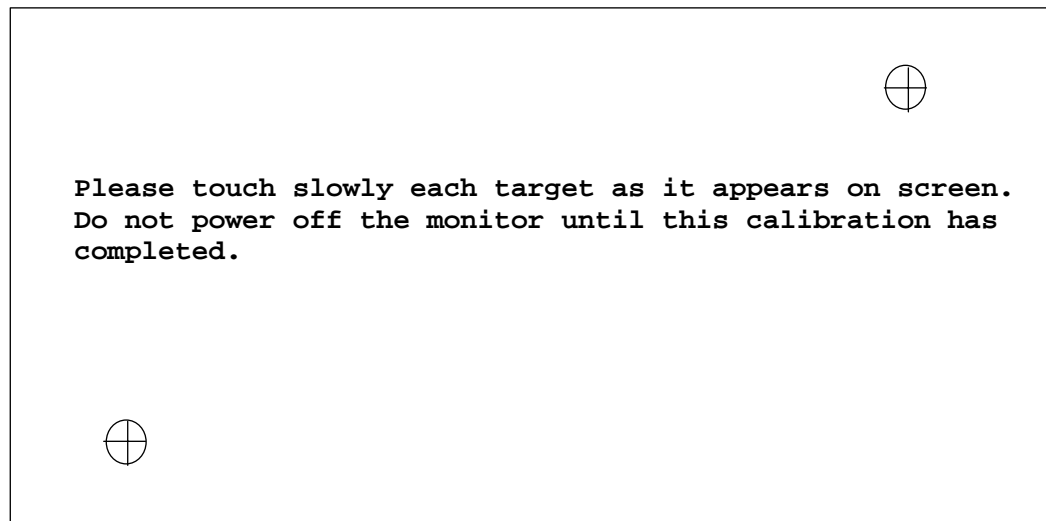

***Touchscreen Calibration Screen***

Make sure you complete the calibration procedure without powering off the monitor mid-way. If the monitor is powered off after the first point is touched, the touch panel will be deactivated until the touch calibration is performed again.

If the touchscreen is accidentally mis-calibrated by selecting the wrong spot, you must use another input device to re-enter calibration mode. If you have the support tool, you can select **Reset Touch Calibration to Default** and it will create a rough calibration which will allow you to access the calibration menu again via the touchscreen.

Please refer to the documentation shipped with your selected display for further details on touchscreen calibration procedures.

## Disabling/Enabling Touch Operation

To *temporarily* disable touchscreen operation of the monitor, press and hold the **Main Screen** key. A padlock symbol will appear on the key. Press and hold the **Main Screen** key again to re-enable touchscreen operation.

## Printer Test Report

To verify your printer configuration you may want to print a test report.

To print a test report select **Main Setup -> Reports -> Setup Printers -> Print Test Rep.**

Your test report should look like this:

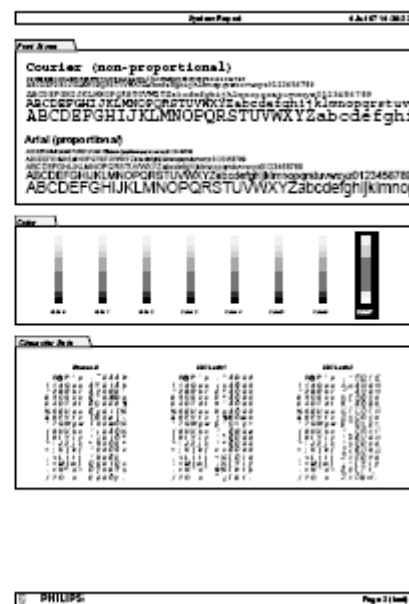
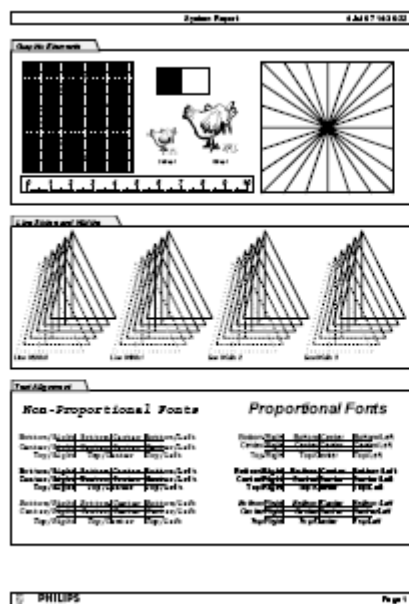



# Battery Handling, Maintenance and Good Practices

This section provides some information on how to handle and maintain the battery in order to get the best usage from them. Additionally, some good working practices are also given regarding the correct disposal of the batteries. This section only applies if a system interface board with battery functionality is installed in the monitor.

## NOTE

If your monitor is connected to an -USR\_ProductName- Information Center, you should make sure that the IIC uses the text catalog revision E.0 or later, otherwise battery INOPs may not display correctly on the IIC. Consult your IIC documentation for instructions on upgrading the text catalog.

## About the Battery

The rechargeable Lithium-Ion battery used in the monitor is regarded as a *Smart* battery because it has built-in circuitry. (This circuitry communicates battery-status information to the Monitor.)

To get the most out of the batteries, observe the following guidelines:

- Condition the battery only upon maintenance request prompt on display.
- **If a battery shows damage or signs of leakage, replace it immediately. Do not use a faulty battery in the Monitor.**
- Capabilities of integrated battery charger: 12.6V, 2.5 Amps max.  
Actual current / voltage: depends on smart battery request and monitor configuration  
The approximate charging time is 4 hours with the monitor switched off and up to 12 hours or more during monitor operation, depending on the monitor configuration.

## NOTE

In certain situations, where many measurements are in use plus the recorder, the load on the monitor may be so high that the batteries will not charge. In this case you must use the M8043A Smart Battery Charger to charge the battery.

- **Battery Disposal**—The battery should be disposed of in an environmentally-responsible manner. Consult the hospital administrator or your local Philips representative for local arrangements.  
**Do not dispose of the battery in normal waste containers.**
- **Battery Storage** — Batteries should not remain inside the monitor if they are not used for a longer period of time. Batteries should be max. 50% charged for storage.

## NOTE

The battery will discharge over time if it is stored inside the monitor without AC power connection. The reported values “remaining capacity” and “runtime” will become less accurate when the battery is stored inside the monitor without AC Power connection for a longer period of time (i.e. several weeks).

## Checking the Battery Status

When the Monitor is connected to the AC power supply, the battery charges automatically. The battery can be charged remotely from the Monitor by using the battery charger. Use only the M8043A Smart battery charger.

Battery status (level of charge) is indicated in several ways:

- LED on the front panel of the Monitor.
- Battery gauge.
- Display of battery time below gauge.
- Battery status window.
- INOP messages.

The AC Power LED is only on when the power cord is connected and AC power is available to the Monitor. In this case, the battery can be either charging or fully charged.

The battery LED can be green, yellow, or red depending on the following conditions:

| Battery LED Colors                 | If the monitor is connected to AC power, this means | If the monitor is running on battery power, this means |
|------------------------------------|---|--|
| <b>Green</b>                       | battery full ( $\geq 90\%$ )                        |  |
| <b>Yellow</b>                      | battery charging<br>(battery power $< 90\%$ )       |  |
| <b>Red, flashing</b>               |   | $\leq 10$ minutes power remaining                      |
| <b>Red, flashes intermittently</b> | battery or charger malfunction <sup>1,2</sup>       | battery or charger malfunction <sup>1,2</sup>          |

1 indicated by malfunction symbol and INOP

2 for further details see Troubleshooting section

## Battery Status on the Main Screen











Battery status information can be configured to display permanently on all Screens. It shows the status of the battery and the battery power and battery time remaining. The battery time is only displayed when the monitor is not running on AC power. Note that the battery status information may take a few minutes after the monitor is switched on to stabilize and show correct values.

Battery power gauge:

This shows the remaining battery power. It is divided into sections, each representing 20% of the total power. If three and a half sections are shaded, as in this example, this indicates that 70% battery power remains. If no battery is detected, the battery gauge is greyed out.

Battery malfunction symbols:

If a problem is detected with the battery, these symbols are displayed. They may be accompanied by an INOP message or by a battery status message in the monitor information line (if battery window is open) providing more details.

| Battery Status Symbols  |   |
|---|---|
|   | Battery requires maintenance  |
|  | Battery is empty  |
|  | Battery not charging as the temperature is above or below the specified range |
|  | Charging stopped to protect the battery                                       |
| Battery Malfunction Symbols   |   |
|  | Incompatible Battery  |
|  | Battery Malfunction   |
|  | Battery temperature too high  |
|  | Battery has no power left   |

Explanations of Battery Status and Malfunction Symbols:

*Battery requires maintenance:* The battery requires conditioning. Refer to “Conditioning Batteries” for details.

*Battery is empty:* The capacity of the battery is  $\leq 10$  min. Recharge the battery as soon as possible.

*Temperature outside specified range:* The charging of the battery is stopped if the temperature is below 15°C or above 50°C in order to protect the battery. Charging is resumed as soon as the temperature is within this range.

*Incompatible Battery:* The inserted battery is checked for certain battery internal parameters. If these are not correct, the incompatible battery symbol is displayed. Please use only M4605A batteries with the MP5 monitor. Note that the incompatible battery symbol may also appear if there is a communication problem between the battery and the battery board.

*Battery Malfunction:* Communication between the battery and the battery board could not be established within about 4 minutes or battery internal data indicates malfunction. Please see the “Troubleshooting” section for remedies.

*Battery Temperature too high:* This symbol is displayed if the battery temperature goes above 65°C. In addition the INOP message CHECK BATT TEMP is displayed. If the battery temperature increases further above 70°C the batteries will switch off for safety reasons. Allow the battery to cool down to avoid the monitor switching off.

*Battery has no power left:* If the monitor is not running on AC power: battery will switch off power delivery at any moment - in this case recharge the battery immediately - or, if the monitor is running on AC power, the battery is in deep discharge and requires pre-charging to restore communication. To avoid this condition charge batteries to 50% for storage. Note that the battery malfunction INOP will eventually be issued if the pre-charging does not restore battery communication within about 4 minutes.

## Battery Status Window

- ▶ To access the **Battery Status** window and its associated pop-up keys, select the battery status information on the Screen, or select **Main Setup** -> **Battery**.

| Battery Status        |  | ✕     |
|-----------------------|--|-------|
| TimeToEmpty: 4:24 hrs |  |       |
| Capacity              |  |       |
| remaining [mAh]       |  | 4341  |
| fullCharge [mAh]      |  | 5748  |
| Voltage [V]           |  | 11.96 |
| Current [mA]          |  | -847  |
| Temperature [°C]      |  | 26.4  |

**Capacity, Remaining** tells you how much power is left in the battery.

**Capacity, Full Charge** tells you how much power the battery can hold when fully charged.

**Time To Empty** tells you approximately how long you can continue to use the monitor with this battery. Note that this time fluctuates depending on the system load (how many measurements and recordings you carry out), the age of the battery, and the remaining capacity of the battery. The time indication appears after AC has been unplugged for about 30 seconds (after finishing calculation of the Time to Empty)

**Time To Full** is shown in place of **Time To Empty** if the monitor is connected to AC power, and tells you how much time is left until the battery is charged to 90%. Please allow indication to stabilize for 3 to 5 minutes after beginning the charging cycle. If the battery is charged over 90% **Battery Full (>90%)** is displayed until they are charged to 100%. Then **Batt Fully Charged** is displayed.

### Viewing Battery Details

- ▶ To view detailed information for the battery, select the pop-up key **Batt**.

| Batt            |                  |
|-----------------|------------------|
| Model           | PHILIPS M4605A   |
| Chemistry       | LiION            |
| ManufactureDate | 28 Oct 03        |
| S/N             | 00315            |
| Type            | 10.80V / 6000mAh |
| Request         | 12.60V / 4500mA  |
| Cycles          | 30 (3%)          |

### Documenting Battery Status

To print all battery information in the **Battery Status** window,

1. Select the battery status information on the Screen or select **Main Setup** -> **Battery** to open the **Battery Status** window
2. Select the **Record Status** pop-up key to print the information on a recorder  
or  
Select the **Print Status** pop-up key to print the information on a connected printer.

### Conditioning a Battery

#### What is Battery Conditioning?

Battery conditioning recalibrates the battery to ensure that it has accurate information on the actual battery capacity.

### Why is Battery Conditioning Necessary?

The capacity of a battery decreases gradually over the lifetime of a battery. Each time a battery is charged its capacity decreases slightly. Therefore, the operating time of a monitor running on batteries also decreases with each charge cycle.

Battery conditioning ensures that the value stored in the battery for its full capacity takes account of this decrease, so that the remaining battery charge can be calculated accurately, and the low battery warning given at the right time.

### When Should Battery Conditioning be Performed?

Battery conditioning should be performed when indicated by the Battery Status.

#### NOTE

When the battery status signals a conditioning request, the displayed **Time to Full** or **Time to Empty** may not be reliable.

### What Causes the Conditioning Message on the Monitor?

In addition to the value for the full capacity, the battery also stores a value for the Max Error. The Max Error tracks the maximum possible deviation of the estimated charge of a battery from the actual charge.

If a battery is charged or discharged partially, or if it is charged while the monitor is being used, the accuracy of the “reference points” for the fully discharged and fully charged states decreases, causing an increase in the value for the Max Error (see diagram, below).

When the Max Error rises over a certain limit, a message is displayed prompting the user to condition the battery, as described in *Conditioning Batteries* (on page 111).

You can reset the value for the Max Error before the battery needs conditioning, by performing the steps described in “Conditioning Batteries”. The minimum value of the Max Error after conditioning is 2%.

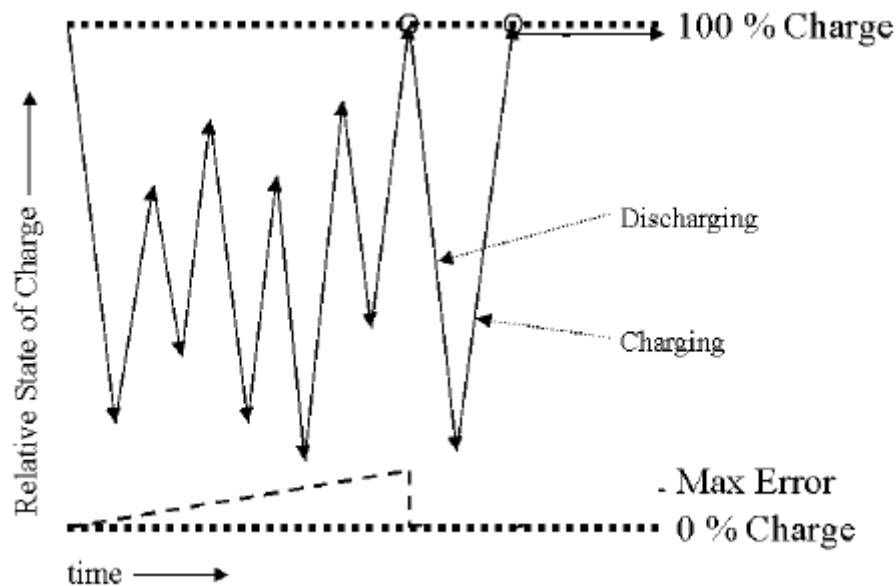

### Conditioning Batteries

Battery conditioning can either be performed in the monitor or with an external battery charger. Philips recommends using the M8043A Smart Battery Charger to condition batteries.

#### Battery Conditioning in the Monitor

---

#### CAUTION

Do not use a monitor being used to monitor patients to condition batteries. The monitor switches off automatically when the battery is empty.

---

You should condition a battery when its “battery requires maintenance” symbol shows on the Screen. If conditioning is not performed immediately the monitor will still function according to specifications. However, the displayed time to empty and time to full will show increasing inaccuracy. Do not interrupt the charge or discharge cycle during conditioning. To condition a battery,

1. Insert the battery into a monitor connected to mains power.
2. Charge the battery until it is completely full. Switch the monitor off to decrease the charging time. When the battery LED turns green i.e. the battery is >90% charged, switch on the monitor and open the **Battery Status** window. Check that the **Battery fully charged** message is displayed.
3. Disconnect the monitor from AC power, and let the monitor run until the battery is empty and the monitor switches itself off.
4. Reconnect the monitor to AC power and charge the battery until it is full for use or charge to 50% for storage.

### **Battery Conditioning with an External Charger**

You can use the M8043A Smart Battery Charger for external battery conditioning. For details please see the IfU for the Smart Battery Charger. Use only the M8043A Smart battery charger.

## **After Installation, Testing or Repair**

Before handing the patient monitor over to the end-user, make sure it is configured appropriately and that it is in monitoring mode. Ensure that the user receives the current revision of the monitor documentation.







---

# Troubleshooting

## Introduction

This section explains how to troubleshoot the monitor if problems arise. Links to tables that list possible monitor difficulties are supplied, along with probable causes, and recommended actions to correct the difficulty.

## How To Use This Section

Use this section in conjunction with the sections *Testing and Maintenance* and *Parts*. To remove and replace a part you suspect is defective, follow the instructions in the section *Repair and Disassembly*. The *Theory of Operation* section offers information on how the monitor functions.

## Who Should Perform Repairs

Only qualified service personnel (biomedical engineers or technicians) should open the monitor housing, remove and replace components, or make adjustments. If your medical facility does not have qualified service personnel, contact Philips' Response Center or your local Philips representative.

---

### WARNING

High Voltage - Voltages dangerous to life are present in the instrument when it is connected to the mains power supply. Do not perform any disassembly procedures (other than server removal) with power applied to the instrument. Failure to adhere to this warning could cause serious injury or death.

---

## Replacement Level Supported

The replacement level supported for this product is to the printed circuit board (PCB) and major subassembly level. Once you isolate a suspected PCB, follow the procedures in the *Repair and Disassembly* section, to replace the PCB with a known good PCB. Check to see if the symptom disappears and that the monitor passes all performance tests. If the symptom persists, swap back the replacement PCB with the suspected malfunctioning PCB (the original PCB that was installed when you started troubleshooting) and continue troubleshooting as directed in this section.

## Software Revision Check

Some troubleshooting tasks may require that you identify the Software Revision of your monitor. You can find the software revision along with other information, such as the system serial number, in the monitor revision screen. To access the monitor revision screen:

1. Enter the Main Setup menu and select **Revision**
2. Select **Product**
3. Select **Software Revision**
4. Select the pop-up key for the device you want to check (e.g. **M8105A**)

### NOTE

The part numbers listed in the monitor revision screen do not necessarily reflect the part numbers required for ordering parts. Please refer to the *Parts* section for the ordering numbers.

### NOTE

The system serial number can also be found on the back of the monitor.

## Compatibility of MP5 in Companion Mode with IntelliVue Patient Monitors

The following table shows the compatibility between IntelliVue Patient Monitor and MP5 software revisions when MP5 is used in Companion Mode as an MMS.

| Host Monitor Software | MP5 Software |     |
|-----------------------|--------------|-----|
|                       | F.0          | G.0 |
| F.0                   | Yes          | Yes |
| G.0                   | Yes          | Yes |

## Compatibility with Information Center

The following tables show the compatibility between the MP2/X2/MP5 and the Information Center software revisions. The first table shows the compatibility if MP2/X2/MP5 are used as pure monitor or measurement module. The second table shows the compatibility if the MP2/X2/MP5 are used in companion mode i.e. as monitor and measurement module.

| MP5/<br>MP2/X2<br>Software | Information Center Software |     |      |     |     |     |     |     |     |
|----------------------------|-----------------------------|-----|------|-----|-----|-----|-----|-----|-----|
|                            | D.01                        | E.0 | E.01 | F.0 | G.0 | H.0 | J.0 | K.0 | L.0 |
| E.0                        | No                          | No  | No   | Yes | Yes | Yes | Yes | Yes | Yes |
| F.0                        | No                          | No  | No   | No  | Yes | Yes | Yes | Yes | Yes |
| G.0                        | No                          | No  | No   | No  | Yes | Yes | Yes | Yes | Yes |

| MP5/X2<br>Software | Information Center Software |     |      |     |     |     |     |     |     |
|--------------------|-----------------------------|-----|------|-----|-----|-----|-----|-----|-----|
|                    | D.01                        | E.0 | E.01 | F.0 | G.0 | H.0 | J.0 | K.0 | L.0 |
| F.0                | No                          | No  | No   | No  | No  | No  | No  | Yes | Yes |
| G.0                | No                          | No  | No   | No  | No  | No  | No  | Yes | Yes |

## Obtaining Replacement Parts

See *Parts* section for details on part replacements.

## Troubleshooting Guide

Problems with the monitor are separated into the categories indicated in the following sections and tables. Check for obvious problems first. If further troubleshooting instructions are required refer to the Troubleshooting Tables.

Taking the recommended actions discussed in this section will correct the majority of problems you may encounter. However, problems not covered here can be resolved by calling Philips Response Center or your local representative.

### Checks for Obvious Problems

When first troubleshooting the instrument, check for obvious problems by answering basic questions such as the following:

1. Is the power switch turned on?
2. Is the battery adequately charged?

3. Is the AC power cord connected to the instrument and plugged into an AC outlet?

### Checks Before Opening the Instrument

You can isolate many problems by observing indicators on the instrument before it is necessary to open the instrument.

#### NOTE

It takes several seconds for the AC Power LED to switch on / off after the mains power cord has been connected / disconnected.

### Checks with the Instrument switched Off

- AC connected, without battery:
  - AC Power LED is on (green).
- AC connected, with battery:
  - AC Power LED is on (green).
  - Battery LED is green if battery is fully loaded, yellow if battery is being charged.
  - Battery LED red and blinking signals battery or charger malfunction. See *Battery-related problems*.
- No AC connected, with battery:
  - All LEDs are off.

### Checks with the Instrument switched On, AC connected, without battery

When the monitor is first switched on the AC Power LED switches on and stays on. The Power On/Error LED lights up red and then switches to green and stays on.

### Checks with the Instrument switched On, AC connected, with battery

When the monitor is first switched on the AC Power LED switches on and stays on. The Power On/Error LED lights up red and then switches to green and stays on. Battery LED is either green or yellow

### Checks with the Instrument switched On, AC not connected, with battery

When the monitor is first switched on the Power On/Error LED lights up red and then switches to green and stays on.

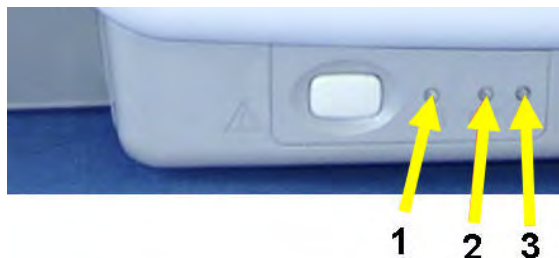

| No. | Description                    |
|-----|--------------------------------|
| 1   | Power On/Error LED (Green/Red) |
| 2   | Battery LED (Green/Red/Yellow) |
| 3   | AC Power LED (Green)           |

**Initial Instrument Boot Phase**

The following tables describe the regular initial boot phase of the monitor and its components. If the boot phase does not proceed as described below go to Boot Phase Failures for Troubleshooting information.

Monitor Boot Phase:

For these steps it is assumed that the Monitor is powered correctly and the +3,3 V System Board supply voltage is okay. This is indicated by the green Power On LED.

| Time (sec.) after Power On | Event   |
|----------------------------|---|
| 0                          | When the Power On/Off button is pressed, the combined Power On and Error LED switches on immediately and is red.  |
| 3                          | The alarm LEDs are switched on with low intensity. Colors: Left LED:cyan; Middle LED:red; Alarm Suspend LED (right): red. Power On/Error LED switches to green. |
| 6                          | Boot Screen with the Philips Logo appears on the display.   |
| 7                          | Test Sound is issued.   |
| 10                         | Alarm LEDs are tested in the following sequence:<br>Cyan on-off (left LED only)<br>Yellow on-off (left & middle LED)<br>Red on-off (all LEDs)                   |
|                            | Boot Screen with the Philips Logo disappears  |
|                            | Fixed screen elements (for example smart keys, alarm fields) appear on the screen.  |
| 15-30                      | First measurement information appears on the screen, touchscreen is functional  |

## Troubleshooting Tables

The following tables list troubleshooting activities sorted according to symptoms. Click on the links below to view a particular table.

### NOTE

Be sure to check all cable connections within the monitor before proceeding to further troubleshooting.

### NOTE

Removing the system interface board erases the status log of the monitor. Please make sure to save the status log using the support tool before removing the system interface board. Refer to the support tool instructions for use for further details.



## How to use the Troubleshooting tables

The possible causes of failure and the remedies listed in the troubleshooting tables should be checked and performed in the order they appear in the tables. Always move on to the next symptom until the problem is solved.

Boot Phase Failures

Integrated Display is blank

Touch Operation not functioning

External Display is blank (Slave Display)

General Monitor INOP Messages

***MSL-related problems (not for MP5T)*** (on page 127)

***Battery related problems*** (on page 128)

***Bedside Network Status Icons (not for MP5T)*** (on page 130)

***Network related problems (not for MP5T)*** (on page 130)

***IIT-related Problems (not for MP5T)*** (on page 132)

***IntelliVue 802.11 Bedside Adapter Problems (not for MP5T)*** (on page 132)

***Short Range Radio Interface Problems*** (on page 133)

Alarm Lamps

Alarm Tones

***Power Loss Alarm Buzzer Problems*** (on page 135)

Individual Parameter INOPs

***Predictive Temperature Problems*** (on page 136)

***Telemetry Device related Problems (TAAP)*** (on page 138)

***Printer (not for MP5T)*** (on page 139)

***Recorder*** (on page 140)

***MIB / RS232 (not for MP5T)*** (on page 140)

***Basic Nurse Call Relay (not for MP5T)*** (on page 142)

***Troubleshooting the ECG OUT (not for MP5T)*** (on page 142)

***Troubleshooting the ECG Sync Pulse (not for MP5T)*** (on page 142)

## Boot Phase Failures

| Symptoms  | Possible Causes of Failure  | Failure Isolation and Remedy   |
|---|---|--|
| AC LED does not light up  | AC Connection not ok  | Check that the AC-Mains are powered and the power cord is ok and connected   |
|   | Power supply defective  | Exchange Power Supply  |
|   | System Interface Board defective  | Exchange System Interface Board  |
|   | Main Board defective  | Exchange Main Board  |
| Combined Power On/Error LED remains off after pressing power on button:       | Remote Devices  | Disconnect all connections to the remote devices and try to switch on the monitor again  |
|   | Recorder PCA defective<br>IIT module defective<br>Flat Panel defective<br>Backlight Inverter defective<br>integrated measurements defective | Disconnect cables and boards:<br>- Recorder PCA<br>- IIT module<br>- Flat Panel<br>- Backlight Inverter<br>- Measurement Block<br>then try to switch on the monitor again. |
|   | System Interface Board defective  | Exchange System Interface Board and try to switch the monitor on again.  |
|   | Main Board defective  | Exchange main board. Add boards in reverse order and try again with each board.  |
| AC Power LED or Power On/Error LED remain off after pressing Power on button: | Main board defective  | exchange main board  |
| Red Power On/Error LED stays on continuously                                  | External connected device defective   | disconnect all external cables (except AC) and switch the monitor on again   |

| Symptoms  | Possible Causes of Failure  | Failure Isolation and Remedy  |
|---|---|---|
|   | Flex adapter cable defective<br>MSL board defective<br>Recorder PCA defective<br>System Interface Board defective<br>IIT module defective | Disconnect cables and boards: (except Power DC/DC cable):<br>- Flex adapter cable<br>- MSL<br>- Recorder PCA<br>- System Interface Board<br>- IIT module<br>then try to switch on the monitor again.  |
|   | Main board defective  | Exchange Main board   |
| Red Power On/Error LED blinks (indicating cyclic reboots) | Software Fault  | connect Support Tool directly to monitor with crossover cable and start “search for defective devices”<br><br>If the Support Tool can detect the device and it indicates the Operating Mode is ‘Boot’, download and store the status log. Reload software and re-clone the monitor. If this fixes the problem e-mail the status log to your local response center |
|   | Hardware Failure  | If no device is detected or if reloading the software does not fix the problem, proceed as described above in section “Red error LED stays on continuously”   |
| Alarm LEDs remain off:                                    | Main board defective  | Exchange Main board   |
| No Test Sound issued                                      | Speaker defective   | check for INOPs and follow instructions<br>exchange speaker   |
|   | Main board defective  | exchange main board   |

**Integrated Display is blank**

| <b>Symptoms</b>   | <b>Possible Causes of Failure</b>      | <b>Failure Isolation and Remedy</b>  |
|---|--|--|
| Integrated display is blank<br>(The information listed in this table is only valid if the boot phase has completed without error. See Boot Phase Failures table for a description of the Boot phase.) |  | If you have an external display, connect it to the video port. If the external display works, you can most likely eliminate the main board as the cause of failure. If the external display also does not work, see also “External Display is blank” |
|   | Flexible Display cable not connected   | Check Flexible Display cable connection to main board and display  |
|   | Backlight Inverter Cable not connected | Check cable connection of main board to Backlight Inverter Board   |
|   | Backlight tube cable not connected     | Check cable connection from Backlight tube to Backlight Inverter board.  |
|   | Backlight tubes defective              | If there are visible fields on the LCD screen when it is switched on but the display stays dark, the backlight tubes are most likely defective. Replace backlight tubes  |
|   | Backlight Inverter board defective     | If backlight tubes have already been replaced, replace backlight inverter board.   |
|   | LCD Flat panel defective               | Replace LCD Flat panel   |
|   | Main board defective                   | Replace main board   |

**Touch Operation not functioning**

| Symptoms                     | Possible Causes of Failure  | Failure Isolation and Remedy  |
|------------------------------|---|---|
| Touch Screen not functioning | Touchscreen functionality has been temporarily disabled                 | Check if touchscreen functionality has been temporarily disabled (padlock symbol on Main Screen key). If yes, press and hold the Main Screen key to re-enable touchscreen operation.            |
|                              | Previously stored touch calibration is lost due to main board exchange. | Calibrate touch (initial) using the support tool.   |
|                              | Touch panel cable not connected   | Check connection from main board to touch panel   |
|                              | Backlight tube cable is positioned close to the touch sensor            | Refit the backlight tube cable into its clip.   |
|                              | Touch sensor defective  | Replace touch sensor<br><b>Note:</b> recalibration of touch necessary   |
|                              | Main board defective  | Replace main board  |
| Touch Position invalid       | Touch not calibrated  | Perform touch calibration:<br>1. Enter the Main Setup Menu<br>2. Select Hardware<br>3. Select Touch Driver Settings<br>4. Select Calibrate<br>or use the support tool to calibrate touch screen |

**External Display is blank (Slave Display)**

| Symptoms                  | Possible Causes of Failure                                 | Failure Isolation and Remedy                                    |
|---------------------------|--|---|
| External Display is blank | Video cable to external display not connected or defective | Check video cable connection to external display                |
|                           | External display has no power                              | Check electricity supply of external display                    |
|                           | External display is defective                              | Check external display and video cable on another monitor or PC |
|                           | System Interface board defective                           | Replace System Interface board                                  |
|                           | Main board defective                                       | Replace main board  |

**General Monitor INOP Messages**

| INOP Message                                    | Possible Causes of Failure   | Failure Isolation and Remedy   |
|---|--|--|
| CHECKINTERNVOLTA<br>GE<br>CHECK MONITOR<br>FUNC | Problem with too low voltages (5V, 12V) in the monitor. Alarm lamps, display or interfaces may not function correctly. | Disconnect cables of:<br>- all measurement boards<br>- Recorder board<br>- IIT or WLAN<br>- NBP Pump<br>and reconnect them one at a time to isolate any defective board. |
|   | Main board defective   | Replace the main board   |
| CHECK MONITOR<br>TEMP                           | The temperature inside the monitor is too high   | Check the environment for possible causes  |
|   | Monitor ventilation obstructed   | Clean the monitor ventilation internally and then cool monitor down for 8 hours  |
|   | Main Board defective   | replace Main Board   |
| SETTINGS<br>MALFUNCTION                         | Problem during cloning process.  | Reclone configuration file   |
|   | Memory space in which the settings are stored has been corrupted   | Reclone configuration file. This will reload the memory space.   |

| INOP Message | Possible Causes of Failure | Failure Isolation and Remedy |
|--------------|----------------------------|------------------------------|
|              | Main board defective       | Replace Main board           |

**MSL-related problems (not for MP5T)**

| Symptoms   | Possible Causes of Failure   | Failure Isolation and Remedy  |
|--|--|---|
| MP5 does not start up when connected via MSL to host monitor | MP5 not powered  | Connect MP5 to AC power or insert charged battery. MP5 does not receive power via MSL.  |
|  | Feature “Power up on MSL power” not functioning  | Check external MSL cable and exchange if necessary.<br><br>Check internal flat ribbon cable between MSL board and system interface board. Replace if defective.<br><br>Check MSL board, system interface board, main board and exchange if necessary. |
| Unsupported MMS INOP is issued                               | Incompatible software revision on MP5 or host monitor. (Companion Mode requires SW rev. F.0 or higher) | Upgrade your monitor software accordingly.  |
| INOP BAD SERVER LINK is issued                               | Communication between MP5 and the host monitor via MSL corrupted                                       | Check external MSL cable and exchange if necessary.<br><br>Check internal flat ribbon cable between MSL board and system interface board. Replace if defective.<br><br>Check MSL board, system interface board, main board and exchange if necessary. |
| INOP CHK MSL CONNECTION is issued                            | MP5 detects MSL power but receives no valid PSYNC signal   | External MSL cable defective. Exchange MSL cable. (Assumption: Host Monitor is functioning correctly)   |

| Symptoms  | Possible Causes of Failure   | Failure Isolation and Remedy  |
|---|--|---|
| MP5 not communicating with host monitor via MSL       | Hardware for communicating with host monitor is defective.             | Check external MSL cable and exchange if necessary.<br><br>Check internal flat ribbon cable between MSL board and system interface board. Replace if defective.<br><br>Check MSL board, system interface board, main board and exchange if necessary. |
| no ECG-OUT at host monitor (MP5 is in companion mode) | Hardware for communicating with host monitor is defective              | Check external MSL cable and exchange if necessary.<br><br>Check internal flat ribbon cable between MSL board and system interface board. Replace if defective.<br><br>Check MSL board, system interface board, main board and exchange if necessary. |
| NG-LAN to central not functioning                     | MP5 connected via MSL cable to host monitor switches NG-LAN at MP5 off | Remove MSL cable  |

### Battery related problems











| Symptoms   | Causes of Failure   | Failure Isolation and Remedy  |
|--|---|---|
| Battery symbol is not displayed  | The monitor is not configured for battery operation.  | Make sure a system interface board with battery capability is installed.  |
| <b>BATT EMPTY</b> INOP tone, battery LED flashes<br>During this INOP, alarms cannot be paused or switched off. | The estimated remaining battery-powered operating time of the battery is $\leq 10$ minutes. | Insert full battery or recharge the battery immediately.<br><br>If the condition persists, this INOP is re-issued two minutes after you acknowledge it. |
| BATT INCOMPAT  | The indicated battery cannot be used with this monitor.                                     | Replace with the correct battery (M4605A).  |



| Symptoms   | Causes of Failure   | Failure Isolation and Remedy  |
|--|---|---|
| INOP tone  | Communication problem between system interface board and main board.  | <p>Check battery in a different monitor. If INOP persists replace battery.</p> <p>Check system interface board using a known good battery. If INOP persist, replace system interface board.</p>   |
| <b>BATT LOW</b><br>INOP tone   | The estimated battery-powered operating time remaining is less than 20 minutes.   | Insert full battery or recharge the battery   |
| <b>BATT MALF</b><br>INOP tone, battery LED flashes<br>During this INOP, alarms cannot be paused or switched off if the monitor is not connected to AC power. | The monitor cannot determine the battery status or there is a communication problem between the battery and the main board. | <p>Replace the faulty battery. If the condition persists and the monitor is not connected to AC power, this INOP is re-issued two minutes after you acknowledge it.</p> <p>Check the battery in a different monitor or in a battery charger. If the INOP persists the battery is faulty.</p> <p>Check the system interface board with known good batteries. If the INOP persists, replace system interface board.</p> <p>If the problem persists, replace main board.</p> |
| <b>CHARGER MALFUNCT</b><br>INOP tone, battery LED may flash  | There is a problem with the battery charger in the monitor.   | Switch the monitor off and back on again. If the problem persists replace battery with known good battery. If the INOP is shown again replace the system interface board. If the problem persists replace the main board.   |
| <b>CHECK BATT TEMP</b><br>INOP tone  | The temperature the battery is too high.  | Check that ventilation openings are not blocked and monitor is not exposed to heat.   |

## Bedside Network Status Icons (not for MP5T)

The following table shows the icons displayed on the monitor when network related issues occur.

| Wireless Icon   | Wired Icon  | Inverse Video | Blinks | Icon Comments   | Inop Message                       | What does it mean?  |
|---|---|---------------|--------|---|------------------------------------|---|
| No icon   | No icon   | -             | -      | -   | -                                  | MONITOR does not have a LAN connection (Wireless MONITOR cannot find an access point to talk to, wired MONITOR cannot hear anything on its LAN connection)  |
|  |  | Yes           | Yes    | Central - outline only  | "UNSUPPORTED LAN" (after 1 minute) | MONITOR has a LAN connection but does not have an IP address assignment (Wireless MONITOR has found an access point to talk to, wired MONITOR hears traffic on the LAN)   |
|  |  | No            | No     | Central - outline only  | "NO CENTRAL MONITORING"            | MONITOR is connected to the LAN and has an IP address assignment, but the bed is not being monitored at the central<br>1. MONITOR is not assigned to a sector<br>2. There is another monitor on the network with the same "Equipment Label" |
|  |  | No            | No     | Central - solid box   | -                                  | Normal Operation - MONITOR assigned to a sector and is being monitored by a central   |
| -   |  | No            | No     | Central - solid box, network line extended                    | -                                  | Normal Operation - MONITOR assigned to a sector and is being monitored by a central<br>This monitor also has OVERVIEW functionality on other beds   |
|  | -   | No            | Yes    | Central - solid box   | "WIRELESS OUT OF RANGE"            | Wireless MONITOR that currently is being monitored by a central is losing contact with the access point and cannot find another to talk to  |
|  |  | Yes           | Yes    | Central - outline only, line for broken connection to central | "NO CENTRAL MONITORING"            | Monitor lost connection to the Information Center:<br>1. LAN cable was disconnected<br>2. Information Center was disconnected<br>3. Network infrastructure failure (switch, etc.)<br>4. Out of range (wireless MONITOR)                     |

## Network related problems (not for MP5T)

| Symptoms   | Possible Causes of Failure  | Failure Isolation and Remedy  |
|--|---|---|
| Prompt Message "no central assigned to this bed" is issued | The monitor label is not set in the monitor (if the beds are "monitor labeled" in the IntelliVue Information Center (IIC))                              | Set Monitor Label in Config Mode  |
|  | Problem with the IntelliVue Information Center (IIC) to Switch communication (if the beds are "port mapped" in the IntelliVue Information Center (IIC)) | Check IntelliVue Information Center (IIC) to Switch communication, Switch configuration and Firmware status |

| Symptoms  | Possible Causes of Failure   | Failure Isolation and Remedy   |
|---|--|--|
| INOP “Unsupported LAN” is issued. One of the following icons is displayed.                    | Network failure  | Check if network switches, IntelliVue Information Center (IIC) and Database Server are all running and connected to the network  |
|   | Monitor connected to wrong network   | Check if monitor has been connected for example to a different hospital network instead of the Philips Clinical Network  |
|   | IP address conflict after infrastructure re-installation   | Reboot Database Server and IntelliVue Information Center (IIC)   |
| No connectivity to IntelliVue Information Center (IIC), no prompt or error message on monitor | Hardware Defect  | Check LAN cable connection   |
|   |  | Check System Interface Board in Monitor  |
|   |  | Check network switch   |
|   | Configuration problem  | Check switch configuration and firmware revision   |
| Other Bed Overview not available  | Configuration Problem  | Check configuration in IntelliVue Information Center (IIC) regarding other bed overview (care group assignment)  |
|   |  | Verify configuration of switch (setting of multicast filters)  |
|   | This function is not available for IntelliVue Instrument Telemetry and, in combination with earlier IntelliVue Information Center (IIC) revisions, for WLAN (IntelliVue 802.11 Bedside Adapter). | If you are using an IntelliVue 802.11 Bedside Adapter, check the software revision of the IntelliVue Information Center (IIC) to make sure it is compatible. If the software revision of the IIC is incompatible or you are using IIT, switch to a wired configuration |

| Symptoms                             | Possible Causes of Failure | Failure Isolation and Remedy   |
|--------------------------------------|----------------------------|--|
| “Other Bed” Alarms are not appearing | Configuration problem      | Verify configuration in IntelliVue Information Center (IIC), in Monitor (Config Mode) and check that the feature is not temporarily disabled by the user (Bed Info Window) |

### IIT-related Problems (not for MP5T)

| Symptoms   | Cause of Failure   | Failure Isolation and Remedy  |
|--|--|---|
| No Network icon or Network icon flashes.<br>No association to central station. | Incorrect RF Access Code. No IP Address.   | Check that RF Access Code is set correctly. Make sure that network is set up correctly.   |
|  | Communication problem between the monitor and the IIT adapter. MAC Instr. Tele. field in Instrument Telemetry Service Window is 0000 0000 0000 | Check that RF Access Code is set correctly and the network is correctly set up.<br><br>Check the flat cable connection between the system interface board and the IIT module.<br><br>Check the antenna cable connection between the IIT module and the antenna.<br><br>Replace flat cable, antenna, antenna cable or IIT module if necessary. |

### IntelliVue 802.11 Bedside Adapter Problems (not for MP5T)

| Symptoms   | Cause of Failure       | Failure Isolation and Remedy  |
|--|------------------------|---|
| No Network icon or Network icon flashes.<br>No association to central station. | Configuration problem. | Make sure that the Mode, SSID, Country and Security settings in the Setup WLAN menu match your installation |

| Symptoms | Cause of Failure  | Failure Isolation and Remedy   |
|----------|---|--|
|          | Communication problem between the monitor and the IntelliVue 802.11 Bedside Adapter or RSSI value below 30. | <p>Ensure that the network infrastructure is functioning properly. See Troubleshooting tables in the IntelliVue 802.11 a/g Infrastructure Installation and Configuration Guide for details.</p> <p>Check the antenna cable connection between the IntelliVue 802.11 Bedside adapter and the antenna.</p> <p>Check the cable connection between the IntelliVue 802.11 Bedside Adapter and the system interface board.</p> <p>Replace cable, antenna, antenna cable or IntelliVue 802.11 Bedside Adapter if necessary.</p> |

**Short Range Radio Interface Problems**

| Symptoms  | Cause of Failure   | Failure Isolation and Remedy   |
|---|--|--|
| Measurement selection icon does not change to SRR.  | Assignment of SRR device to monitor not possible                 | <p>Check SRR Configuration Settings.</p> <p>Replace defective SRR interface or cable, if necessary.</p> <p>Make sure SRR interface is installed.</p> |
|   | SRR interface of telemetry transceiver defective or incompatible | Make sure the telemetry transceiver SRR interface is compatible and functional.  |
| Measurement selection icon changes to SRR but Assignment of SRR device to monitor fails.<br><b>SRR INTERFERENCE</b><br>INOP is issued | RF Interferences   | Check location for RF interferences and free frequencies by performing a site survey (e.g. with air magnet tool).                                    |

| Symptoms  | Cause of Failure  | Failure Isolation and Remedy  |
|---|---|---|
| Communication Dropouts or gaps in parameter waves. <b>SRR INTERFERENCE</b> INOP may be issued     | RF Interferences  | Check location for RF interferences and free frequencies by performing a site survey (e.g. with air magnet tool). |
|   | Too many SRR devices allocated to one SRR channel                 | Up to two SRR connections can be established per channel.<br>Check SRR Configuration Settings.                    |
| SRR communication aborted. <b>SRR INTERFERENCE</b> or <b>SRR INVALID CHAN</b> INOP may be issued. | RF Interferences  | Check location for RF interferences and free frequencies by performing a site survey (e.g. with air magnet tool). |
|   | Too many SRR devices allocated to one SRR channel                 | Up to two SRR connections can be established per channel.<br>Check SRR Configuration Settings.                    |
|   | SRR device out of range (either monitor or Telemetry Transceiver) | Position the SRR devices closer to each other. Check SRR signal quality indicator for signal strength.            |
| Telemetry Device using SRR not recognized by the monitor.   | Telemetry Device not supported by the SRR adapter                 | Make sure you use a telemetry device which is compatible with SRR.  |

### Alarm Lamps

| Symptoms                                 | Possible Causes of Failure        | Failure Isolation and Remedy          |
|--|-----------------------------------|---------------------------------------|
| INOP Message Check Alarm Lamps is issued | Main board defective              | replace Main board                    |
| Alarm occurs, but no LED lights up       | Environmental lighting too bright | Place monitor in a darker environment |
|  | Main Board defective              | Main board                            |

**Alarm Tones**

| Symptoms   | Possible Causes of Failure                         | Failure Isolation and Remedy               |
|--|--|--|
| INOP Message<br>SPEAKER<br>MALFUNCTION is<br>displayed | Speaker cable disconnected                         | Reconnect speaker cable                    |
|  | Speaker defective                                  | Replace speaker                            |
|  | Sound amplifier on main board defective            | Replace main board                         |
| Alarm occurs but no<br>alarm sound is issued           | Audible alarm indicators have<br>been switched off | Switch audible alarm<br>indicators back on |
|  | Volume set to 0                                    | Increase volume                            |
|  | Speaker defective                                  | Replace speaker                            |
|  | Sound amplifier on main board<br>defective         | Replace main board                         |

**Power Loss Alarm Buzzer Problems**

| Symptoms   | Possible Causes of Failure   | Failure Isolation and Remedy      |
|--|--|-----------------------------------|
| Power loss alarm<br>buzzer does not sound<br>when battery is<br>removed and monitor is<br>disconnected from AC<br>power. | Power loss alarm buzzer<br>defective                                       | Replace system interface<br>board |
|  | Communication problem<br>between main board and power<br>loss alarm buzzer | Replace main board                |

**Alarm Behavior**

If your monitor did not alarm in the way in which the end user expected, please consult the Instructions for Use for possible setup issues or configuration settings which could affect alarm behavior.

### Individual Parameter INOPs

If any of the following parameter INOP messages are issued and persist replace the respective measurement. If problem persists, replace the main board.

- CO2 EQUIP MALF
- ECG EQUIP MALF
- NBP EQUIP MALF
- <Pressure Label> EQUIP MALF
- RESP EQUIP MALF
- SpO<sub>2</sub> EQUIP MALF
- SpO<sub>2</sub> TRANSDUC MALF
- <Temp Label> EQUIP MALF
- <pTemp Lbl> EQUIP MALF
- TELE EQUIP MALF

### Predictive Temperature Problems

| Symptoms                          | Cause of Failure  | Failure Isolation and Remedy   |
|-----------------------------------|---|--|
| Incorrect pTemp values            | Wrong label has been chosen<br>e.g. pT <sub>axial</sub> instead of pT <sub>oral</sub> or vice versa         | Choose correct label   |
|                                   | Wrong patient category chosen<br>e.g. adult instead of pediatric or vice versa                              | Choose correct patient category  |
|                                   | Incorrect application of the temperature probe  | Make sure probe is applied correctly to the patient.   |
|                                   | Wrong probe covers used   | Use only recommended probe covers  |
|                                   | Probe defective   | Replace probe  |
|                                   | Predictive temperature assembly defective   | Replace predictive temperature assembly  |
|                                   | Values measured in different places are compared e.g. oral compared with axial                              | Only compare values measured in the same location.   |
| Presumably incorrect pTemp values | Axially or orally measured predictive temperature values do not represent the core temperature of the body. | Only compare values measured in the same location. To obtain T <sub>core</sub> values, choose correct measurement application. |



| Symptoms  | Cause of Failure  | Failure Isolation and Remedy  |
|---|---|---|
| Reference Value displayed on the monitor does not match the value on the Calkey | Defective CalKey  | Replace CalKey  |
|   | Defective CalKey contacts or predictive temperature assembly contacts   | Replace CalKey or predictive temperature assembly if necessary  |
| Predictive temperature label not available                                      | Measurement deactivated<br><br>Connector defective<br><br>Predictive temperature module or measurement connector on monitor defective | Make sure the parameter is switched on and the measurement is activated<br><br>Check the connection between the module and the monitor.<br><br>Try on the same monitor with a known good predictive temperature module. If this solves the problem, replace the module. If problem persists replace measurement block in monitor. |
| pTemp Equip Malf INOP is issued   | Communication problem   | Power cycle the monitor. If problem persists, try again on the same monitor with a known good predictive temperature module. If this solves the problem, replace the module. If problem persists replace measurement block in monitor.  |
| pTemp No Sensor INOP is issued  | Predictive temperature probe is not recognized. Probe connector is damaged.   | Visually inspect the probe connector contacts for damage. Replace probe if necessary  |
| pTemp Transducer Malf INOP is issued  | There is a problem with the predictive temperature probe  | Visually inspect the probe for damage. Disconnect and reconnect the probe. If problem persists, replace the probe.  |
| pTemp Check Probe INOP is issued  | Probe holder not installed correctly or connector damaged   | Check the correct installation of the probe holder. If problem persists, visually inspect the probe connector for damage, disconnect and reconnect the probe. If problem persists, replace probe.   |

## Telemetry Device related Problems (TAAP)

| Symptoms  | Cause of Failure  | Failure Isolation and Remedy   |
|---|---|--|
| TELE UNSUPPORTED INOP message is issued                   | Unsupported Telemetry Device is connected to the monitor  | Make sure your telemetry device has the latest firmware revision   |
| TELE DISCONNECTED INOP message is issued                  | The cable between the telemetry device and the monitor has been disconnected or has fallen off. | Check the cable connections. If cable falls off regularly, replace cable.  |
|   | The SRR link between the telemetry device and the monitor is disrupted.                         | Position the SRR device and the monitor closer to each other. Check SRR signal quality indicator for signal strength.<br><br>Check SRR Configuration Settings.<br><br>Alternatively, use the TAAP cable connection between the telemetry device and the monitor. |
| INVALID LEADSET INOP message is issued                    | see the instructions supplied with the telemetry device   | see the instructions supplied with the telemetry device  |
| REPLACE BATTERY T or BATTERY LOW T INOP message is issued | no battery is inserted in the telemetry device or the battery is low.                           | insert/replace the battery in the telemetry device. <b>Note:</b> If you are using the SRR connection, you must silence the INOPs even when the battery has been replaced. For further details see the instructions provided with the telemetry device.           |
| TELE EQUIP MALF INOP message is issued                    | no stable connection between the telemetry device and the monitor                               | Disconnect and reconnect the telemetry device from the monitor. Remove and reinsert the battery in the telemetry device. If problem persists, replace the telemetry device.  |
| Telemetry Device using SRR not recognized by the monitor. | Telemetry Device not supported by the SRR adapter   | Make sure you use a telemetry device which is compatible with SRR.   |

**Printer (not for MP5T)**

| Symptoms   | Cause of Failure   | Failure Isolation and Remedy   |
|--|--|--|
| <p>Prompt message “Print job could not be queued” is issued. No print device is found.</p>                       | <p>Printer is disabled in the Setup Printers menu</p> <p>Paper size of printer does not match paper size of report</p>   | <p>Enable the correct printer in the Setup Printers menu</p> <p>Change paper size of the printer in the Setup Printers menu or change paper size of the report in the Setup Reports menu.</p>  |
| <p>Status message “Print device Remote 1 (Remote 2, Remote 3) unavailable” is issued. Printer job is stalled</p> | <p>Print error on IntelliVue Information Center (IIC)</p> <p>Network Connection to IntelliVue Information Center (IIC) not functioning</p>   | <p>Print a test report on the IntelliVue Information Center (IIC). If this fails, refer to IntelliVue Information Center (IIC) documentation</p> <p>Check that the network connection between the monitor and the IntelliVue Information Center (IIC) is working</p> |
| <p>Status message “Printing on device Remote 1... (Remote 2, Remote 3)” is issued but no report is printed</p>   | <p>Print queue on IntelliVue Information Center (IIC) is full. Reasons for this may be:</p> <ul style="list-style-type: none"> <li>- Printer is not switched on</li> <li>- Printer paper tray is empty</li> </ul>                        | <p>Switch on printer power</p> <p>Fill printer paper tray</p>  |
| <p>Printouts are not as expected</p>   | <p>Printer paper size is not correctly configured</p> <p>Printer resolution is not correctly configured</p> <p>Printer color support is configured to “On” although the printer does not support color</p> <p>Printer not compatible</p> | <p>Configure the paper size according to the inserted print media</p> <p>Configure the printer resolution according to the printer capabilities</p> <p>Configure the printer color support to “Off”</p> <p>Check specifications</p>                                  |

**Recorder**

| <b>Symptom</b>  | <b>Possible Cause</b>  | <b>Corrective Action</b>  |
|---|--|---|
| Monitor reports that door is open when it is not.                 | Defective door switch.   | Exchange recorder.  |
| Monitor reports that the recorder is out of paper when it is not. | Paper-out sensor dirty.  | Pull paper out a little bit and straighten the paper to make sure it is fixed tightly in the recorder. Make sure the paper has been loaded correctly and that the correct paper has been used. If problem persists, clean paper-out sensor. |
| Content of recording is not as expected                           | Monitor not configured properly.   | Check the configuration of the connected monitor.   |
| Poor print quality  | Paper not inserted correctly   | Check that paper is inserted correctly  |
|   | Printhead dirty.   | Clean the Printhead.  |
|   | Printhead failure.   | Exchange the recorder.  |
| Paper not feeding properly.                                       | Paper roll off center.   | Center paper roll on roller guides.   |
|   | Dirty roller.  | Clean roller.   |
| Recorder not communicating, not printing                          | Loose recorder connector<br>Loose flat cable<br>Recorder defective<br>Recorder Interface defective<br>Main Board defective | Remove and reinsert recorder.<br>Check flat cable connection between recorder board and main board<br>Exchange Recorder<br>Exchange Recorder Interface Board<br>Exchange main board   |

**MIB / RS232 (not for MP5T)**

| Symptoms   | Cause of Failure  | Failure Isolation and Remedy   |
|--|---|--|
| Gas module connected to the RS232 port not functioning | The MIB/RS232 port is not configured for the gas module   | Check configuration of the MIB/RS232 ports in configuration mode   |
|  | The cable between the gas module and monitor is not connected correctly or defective  | Check cable connection, replace cable if necessary   |
|  | The system interface board is defective   | Check board and replace if necessary   |
| External device not receiving data                     | The MIB/RS232 port is not configured for data export  | Check configuration of the MIB/RS232 ports in configuration mode   |
|  | The wrong data export protocol driver is configured in the monitor  | Check the export protocol required by the attached device and configure the monitor accordingly  |
|  | The wrong cable is being used (usually a cross-over cable is needed)  | Choose correct cable (or use an adapter)   |
|  | The cable between the external device and the monitor is not connected correctly or defective                               | Check cable and replace if necessary   |
|  | The external device does not support the version of the data export protocol used in the monitor                            | Check if the device supports the version of the data export protocol. Upgrade device or monitor if necessary (if matching versions exist).                 |
|  | A terminal concentrator is used in between the device and the monitor and a protocol with dynamic speed negotiation is used | Some terminal concentrators do not support changing the transmission speed (baud rate) dynamically. Check if the connection works without the concentrator |
|  | The system interface board is defective   | Check board and replace if necessary   |
| Detailed Protocol Problem                              |   | Consult the Data Export Protocol document.   |

**Troubleshooting the ECG Sync Pulse (not for MP5T)**

| Symptoms          | Cause of Failure                  | Failure Isolation and Remedy   |
|-------------------|-----------------------------------|--|
| No ECG Sync Pulse | Software not configured correctly | Make sure the software is correctly configured (see configuration guide) |
|                   | Wrong cable                       | Make sure you are using the correct cable                                |
|                   | No ECG pulse signal available     | Measure ECG Pulse out with scope.  |

**Troubleshooting the ECG OUT (not for MP5T)**

| Symptoms                                    | Cause of Failure     | Failure Isolation and Remedy   |
|---|----------------------|--|
| No ECG-OUT signal to the Defib              |                      | Disconnect the Defib cable.<br>Connect Known good Defib and Defib cable. Check Marker pulse and ECG OUT signal at defib again. <b>If there is still no signal:</b>   |
|   | Main Board defective | Replace main board   |
| No marker pulse is displayed on the monitor |                      | Disconnect the Defib cable.<br>Connect Known good Defib and Defib cable. Check Marker pulse and ECG OUT signal at defib again. Check Marker pulse on monitor display again. If problem persists exchange the main board. |

**Basic Nurse Call Relay (not for MP5T)**

| Symptoms                                     | Cause of Failure  | Failure Isolation and Remedy                          |
|--|---|---|
| Monitor alarmed, Nurse Call did not activate | Incorrect configuration (Relay latency, Relay trigger)          | Check monitor configuration (see configuration guide) |
|  | Connection of cable to monitor or nurse call system not correct | Check cable connections                               |

| Symptoms | Cause of Failure                        | Failure Isolation and Remedy   |
|----------|---|--------------------------------|
|          | The system interface board is defective | Replace system interface board |

### Image Sticking

If a static image is displayed for a long time on an LCD display, image sticking, i.e. a temporarily retained image, may occur. To eliminate image sticking, switch off the display and switch it back on again. It is also recommended to use the moving image in standby mode.

### Status Log

Many events that occur during start-up or regular monitoring are logged in the Status Log. The Status Log can be printed and cleared. Not all entries in the Status Log are errors.

| Monitor |      |       |   |                |
|---------|------|-------|---|----------------|
| H       | 1720 | 20050 | 1 | 4 Apr 02 16:37 |
| C       | 1721 | 21050 | 1 | 4 Apr 02 15:37 |

The Status Log window shows logged events which caused a reboot of the system component (monitor or measurement block).

To enter the Status Log Window, select Main Setup -> Revision. The following list opens up:

- **Status Log**
- **Product**
- **Appl. SW**
- **Config**
- **Boot**
- **Language**

Select **Status Log**.

The first column in the log identifies the event class (“C”: caused a cold start, “H”: caused a hot start, “N”: no restart, for information only). Column 3 and 4 identify the event source and event code. Column 4 counts the number of occurrences of the event. The last column shows the time and date of the last occurrence of the event.

**Cold Start:** A cold start erases patient data incl. ADT, trends and customer configuration settings.

**Hot Start:** A hot start is a system reset. No data is erased.

The following pop-up keys overlay the SmartKeys:

|                          |  |  |              |
|--------------------------|--|--|--------------|
| <b>Clear<br/>StatLog</b> |  |  | <b>M8105</b> |
|--------------------------|--|--|--------------|

**Clear StatLog**

This key clears the currently displayed Status Log

**M8105**

#### NOTE

This key switches to the Monitor Revision Window

If an event occurs repeatedly, contact your Philips Service Representative.

#### NOTE

It is possible, using the support tool, to download the status log and send it to your Philips Service Representative as a file (for example via e-mail).

### List of Error Codes

There are no error codes at this point.



## Troubleshooting with the Support Tool

Using the support tool you can:

- access the full status log which can be saved as a file
- reload software
- identify defective devices
- reset touch screen calibration

For details on how to perform these tasks see the Support Tool User Manual.

## Troubleshooting the Individual Measurements or Applications

For problems isolated to an individual parameter or application, please consult the Instructions for Use and configuration information.

If you are getting questionable readings for individual measurements you may want to do the Performance Verification tests in the *Testing and Maintenance* section.

The performance of the individual applications (arrhythmia, trending) are affected by the configuration of the monitor. When contacting Philips support you may be asked about the configuration of the monitor to aid in troubleshooting.



---

# Repair and Disassembly

The following section describes the disassembly and reassembly procedures for the monitor and its components.

## Who Should Perform Repairs

Only qualified service personnel (biomedical engineers or technicians) should open the monitor housing, remove and replace components, or make adjustments. If your medical facility does not have qualified service personnel, contact Philips' Response Center or your local Philips representative.

---

### WARNING

High Voltage - Voltages dangerous to life are present in the instrument when it is connected to the mains power supply. Do not perform any disassembly procedures (other than server removal) with power applied to the instrument. Failure to adhere to this warning could cause serious injury or death.

---

### WARNING

The electrical characteristics of anti-static mats should be checked before use, as described in the manufacturer's instructions for continued protection to both you and the equipment.

---

### CAUTION

Before handling any circuit boards, firmly touch the exposed metal on the case to equalize the ground potentials. This will prevent static discharge and protect the logic components of the monitor.

Handle circuit boards on the edges only; avoid touching board surfaces unless performing circuit board repair. Contaminants like skin oil will attract dust to accumulate which could retain moisture and affect the circuit performance.

---

## Tools required

- Torx screwdrivers (sizes 6, 8, 10, 20)
- mCO<sub>2</sub> Luer Remover
- Small flat head screwdriver
- 1 small Pozi or Philips head screwdriver
- Needle Nose Pliers
- ESD mat and wrist strap
- Cleaning Agent

Recommended cleaning agents are:

|                                  |   |
|----------------------------------|---|
| Tensides (dishwasher detergents) | Edisonite Schnellreiniger <sup>â</sup> , Alconox <sup>â</sup> |
| Ammonias                         | Dilution of Ammonia <3%,<br>Window cleaner                    |
| Alcohol                          | Ethanol 70%, Isopropanol 70%,<br>Window cleaner               |

## Removing the Handle or Bedhanger

1. Unscrew the two screws securing the handle/bedhanger and pull off the handle/bedhanger.



### NOTE

There are two versions of the bedhanger. The old version (MP5/MP5T Handle Bed hanger, M8100-44902, 12NC: 451261019361) is no longer orderable. The new version (MP5/MP5T Handle bed hanger non-slip, M8105-60112, 12NC: 451261023691) has an integrated anti-slip protection to reduce slipping from a bed rail. The picture below shows the new bedhanger.



**Removal of the handle or bedhanger is not required for opening the monitor.**

## Removing the Predictive Temperature Assembly

1. Unplug the sensor connector at the back of the predictive temperature assembly and remove the probe and its housing from the assembly.



2. Remove the white pin at the back of the assembly by turning it counterclockwise with a screwdriver and then pulling it out.



3. Unscrew the two screws at the bottom of the monitor and pull off the predictive temperature assembly to the side.



4. Reassemble the predictive temperature assembly by performing the above steps in reverse order.

## Disassembling the Predictive Temperature Assembly

1. Unscrew the three self-tapping screws holding the assembly together, remove the rubber sealing from the predictive temperature assembly and separate the two halves of the assembly.



2. Unscrew the two screws securing the predictive temperature board.

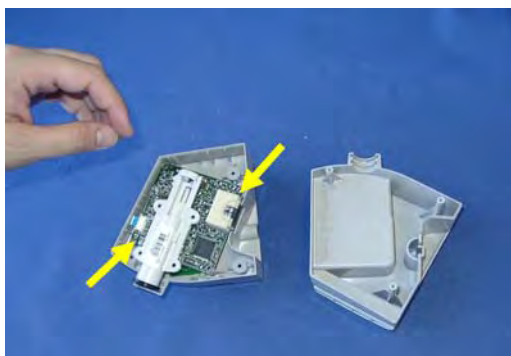



3. Flip the predictive temperature board to the side out of the housing and remove the three screws from the small connector board. Open the connector and release the cable. Then remove the connector board. Remove the black sealing ring from the predictive temperature probe tube.

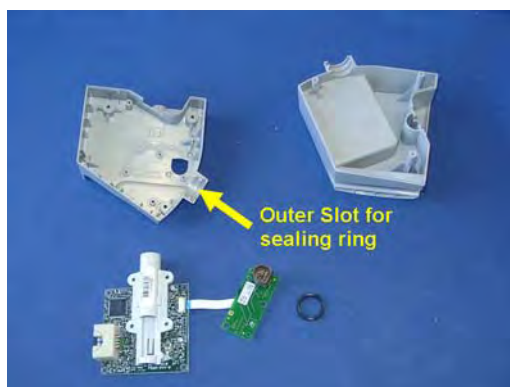
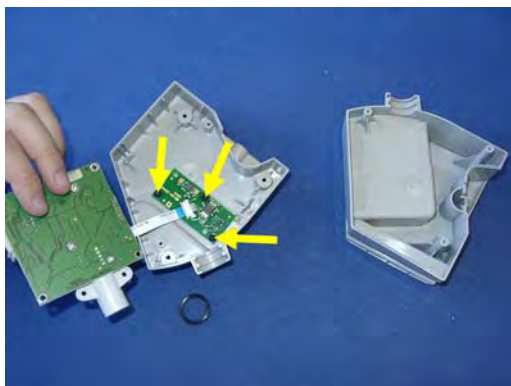

4. For reassembly, perform the above steps in reverse order.

**Reassembly Note:** When reattaching the small connector board to the housing, do not overtighten the screws. The board should sit loosely in the housing. The black sealing ring must be inserted into the outer of the two slots in the housing.

## Separating the Front and Back of the Monitor

1. Remove the Predictive Temperature Assembly as described above.

2. Open the battery compartment, push up the battery compartment latch and remove the battery from the battery compartment by pulling on the tab.



3. Open the recorder, remove the recorder paper and locate the two screws inside the recorder.



4. Unscrew the two screws inside the internal recorder and pull out the recorder. Note that these screws will not come out completely but remain in the recorder housing.



5. Remove the two screws securing the quick mount cover.



6. Insert a screwdriver into the slots at the bottom of the quick mount cover and push the cover off on each side. Then pull the quick mount cover off the monitor.

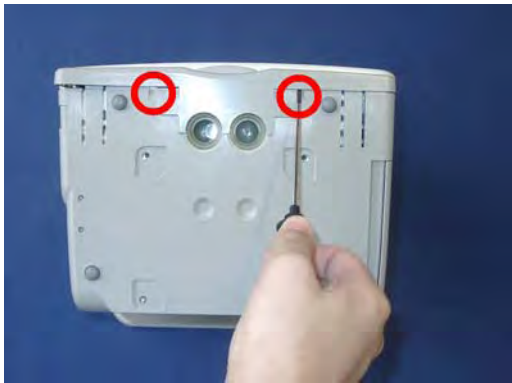

7. Remove the cover branding clip.



8. Release the white pins at the top and the bottom of the monitor by turning them counterclockwise with a flat-tipped screwdriver and then pull them out as shown below.



9. Insert a screwdriver into the outer slots (on the outside of the latches of the white housing) on both sides to loosen the rear cover and then lift the back of the monitor off.

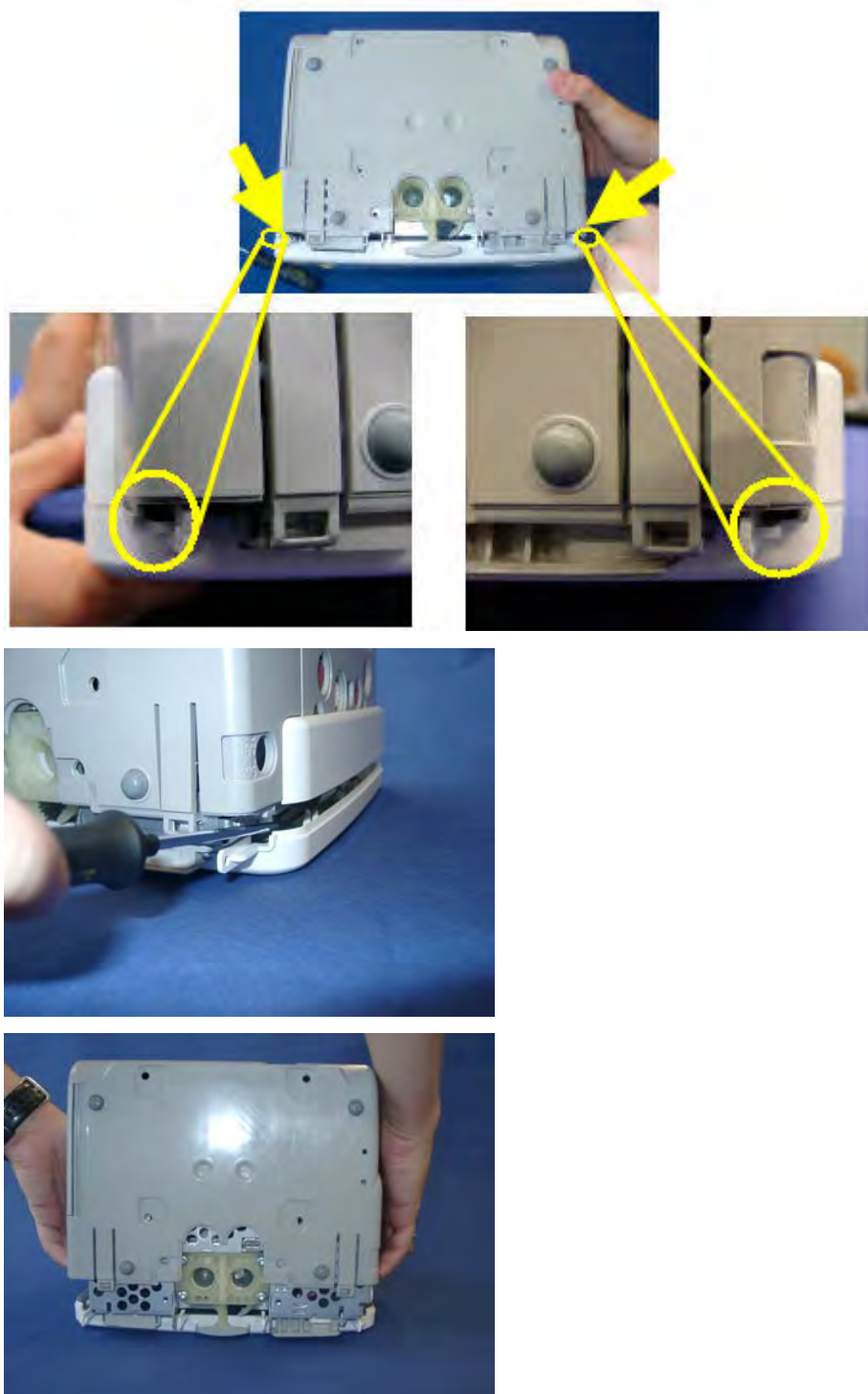

10. Reassemble the monitor by performing the above steps in reverse order.

## Removing the Recorder Slot Cover

If you do not have a recorder installed in your monitor, you will have to remove the recorder slot cover before a recorder installation. Depending on which version of the monitor you have, the securing mechanism of the cover may vary.

### Old version:

- Remove the cover by pressing in the three snaps



### New Version:

1. Release the white pin securing the recorder slot cover.
2. Release the cover by pressing in the three snaps (see old version above).





## Removing the Internal Quick Mount Solution

1. Remove the Predictive Temperature Assembly as described above.
2. Separate the front and back half of the monitor as described above
3. Unscrew the screws securing the quickmount and remove the quick mount.



4. For reassembly, perform the above steps in reverse order.

## Removing the Short Range Radio (SRR) Interface

The SRR interface consists of a combined antenna and interface board. It is connected via a ribbon cable to the main board.

1. Remove the predictive temperature assembly as described above.
2. Separate the front and back of the monitor as described above.

3. Disconnect the ribbon cable connecting the SRR board and the main board from the main board.

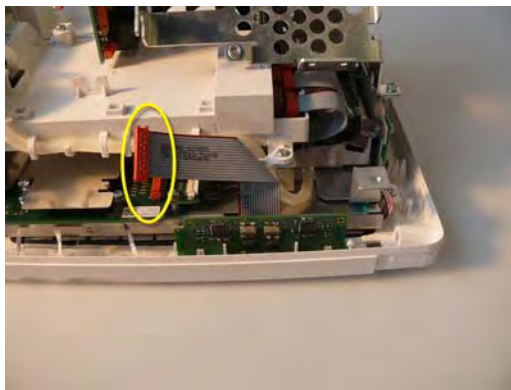
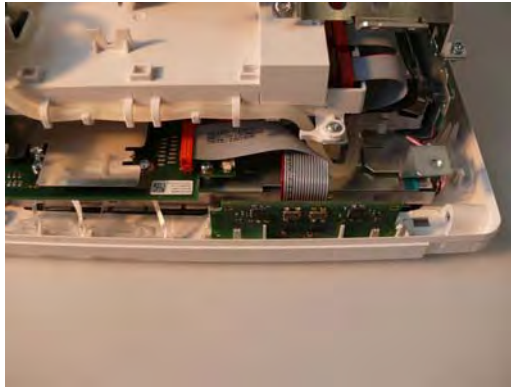

4. The board is locked into its position by a latch on the right. Pull the latch to the right to release the SRR board and lift the board upwards and out.

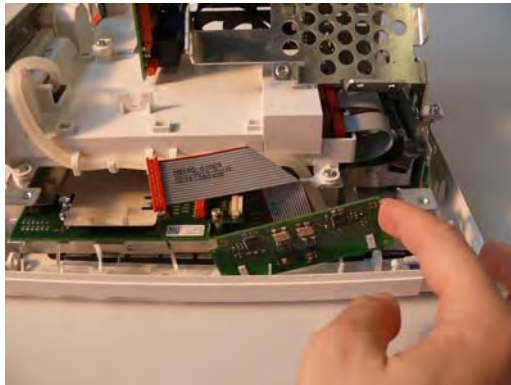



5. Separate the flat ribbon cable from the SRR board.



**Reassembly Note:** When reconnecting the flat ribbon cable to the SRR board the cable must be connected as shown above (i.e. the shorter end attached to the SRR board.)

6. Reassemble the monitor. When reassembling the housing, make sure that the white plastic noses of the rear housing do not scratch or damage the SRR board.



## Removing the IntelliVue 802.11 Bedside Adapter Antenna or IIT Antenna (not for MP5T)

### NOTE

The antenna is a three band antenna and is used with the IntelliVue 802.11 Bedside Adapter as well as with IntelliVue Instrument Telemetry (IIT).

1. Remove the predictive temperature assembly as described above.
2. Separate the front and back of the monitor as described above.
3. Press down the latch at the bottom side of the antenna mounting, then lift up the antenna.

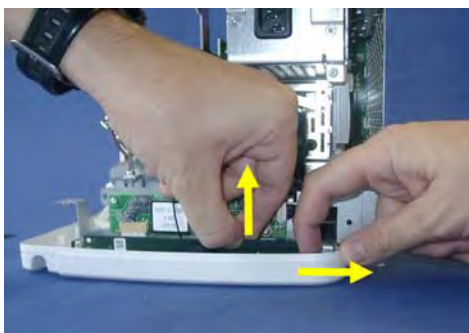

**Reassembly Note:** When reinserting the antenna, press against the black foam piece in the middle to squeeze it into the housing.



## Removing the IntelliVue 802.11 Bedside Adapter (WLAN) (not for MP5T)

1. Remove the predictive temperature assembly as described above.
2. Separate the front and back of the monitor as described above.
3. Unplug the antenna connector from the bedside adapter and pull the cable out of its holder in the white clip on the side.

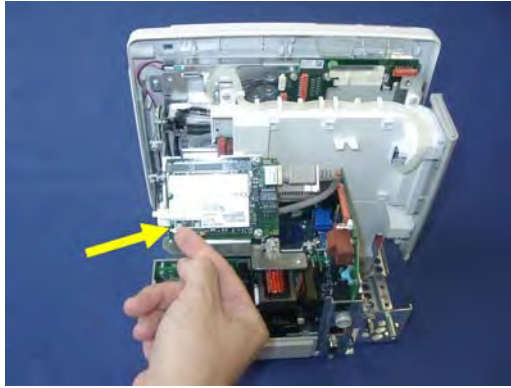

4. Remove the white clip from the bedside adapter.

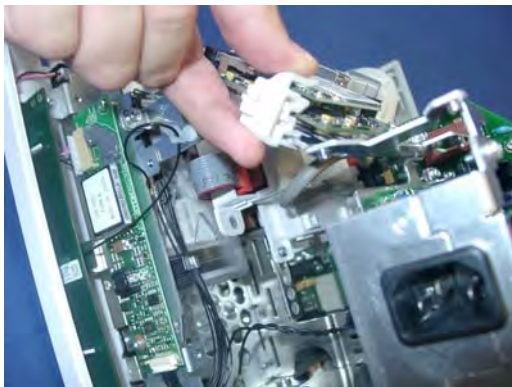
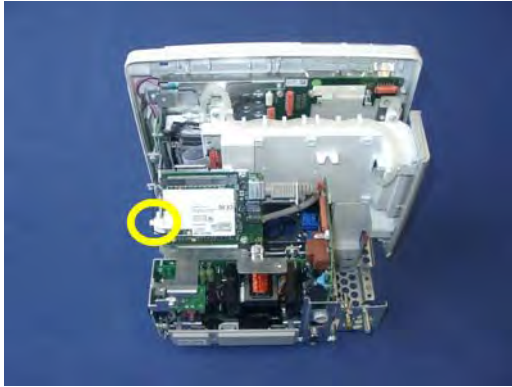

5. Disconnect the bedside adapter from the system interface board.

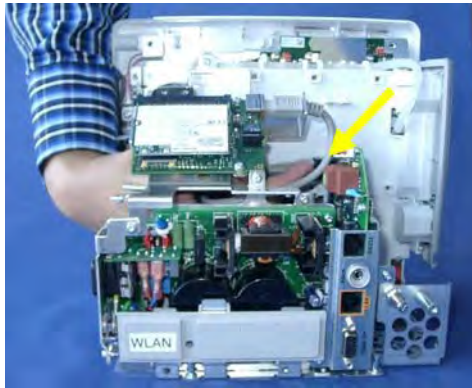

6. Unscrew the two screws on the bedside adapter and remove the module by pulling it upwards.



7. For reassembly, perform the above steps in reverse order.

**Reassembly Note:** When reconnecting the bedside adapter use the outer of the two connectors on the adapter. Make sure that the antenna cable is threaded through the white holders as shown below.

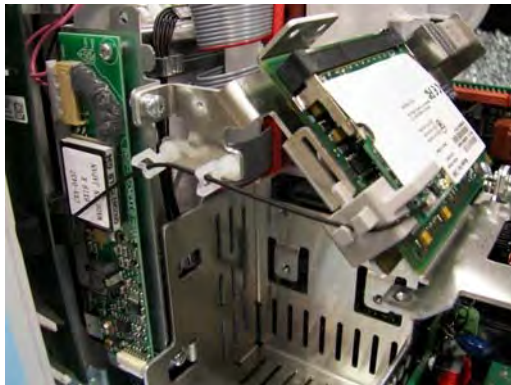



## Removing the IntelliVue Instrument Telemetry (IIT) Module (not for MP5T)

1. Remove the predictive temperature assembly as described above.
2. Separate the front and back of the monitor as described above.
3. Unplug the connector from the IIT Module

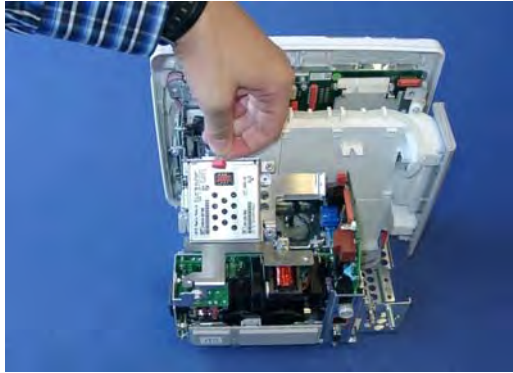

4. Remove the antenna board and unplug the antenna connector from the antenna board.

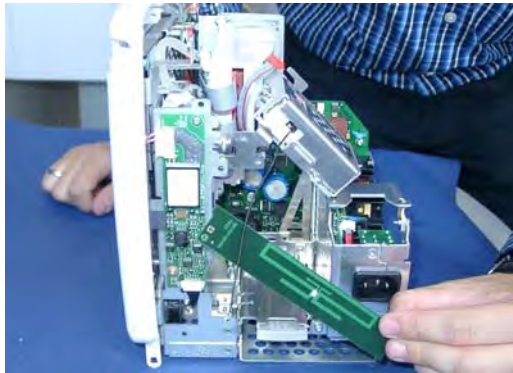

5. Remove the screws securing the IIT module and remove the IIT module.

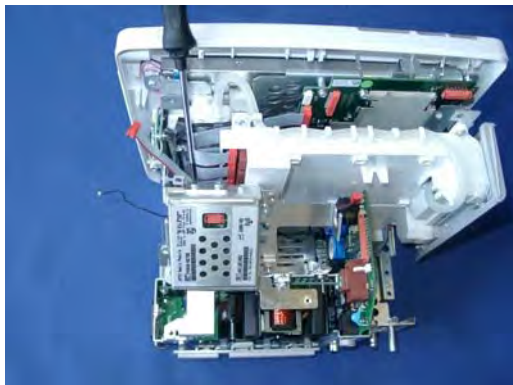

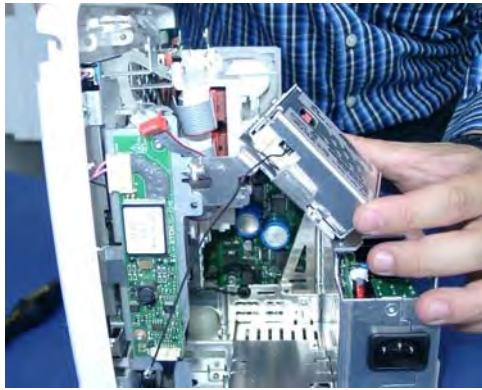

**Reassembly Note:** Depending on the which version of the IIT module you are using the antenna cable needs to be threaded through the cable holders in different ways. The pictures below show the two different versions.

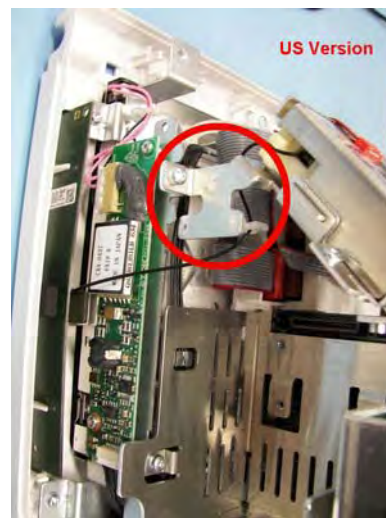

6. For reassembly, perform the above steps in reverse order.

## Removing the IntelliVue 802.11 Bedside Adapter/IIT Holder (not for MP5T)

1. Remove the predictive temperature assembly as described above.
2. Separate the front and back of the monitor as described above.
3. Remove the optional IIT Module or Bedside Adapter as described above.

4. Unscrew the three screws securing the IIT/Bedside Adapter Holder and remove the holder. If an MSL board is installed, disconnect its connector to the interface board.

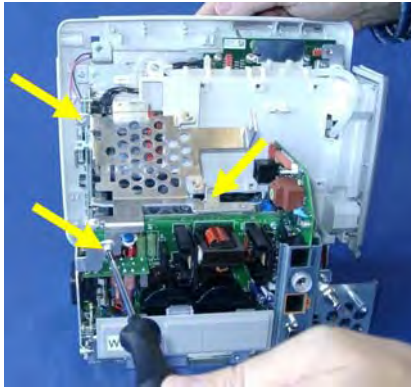

5. For reassembly, perform the above steps in reverse order.

## Removing the MSL Board (not for MP5T)

1. Remove the predictive temperature assembly as described above.
2. Separate the front and back of the monitor as described above.
3. Disconnect the connector from the MSL board to the interface board.



4. Remove the three screws securing the IntelliVue 802.11 Bedside Adapter/IIT holder and remove the holder..

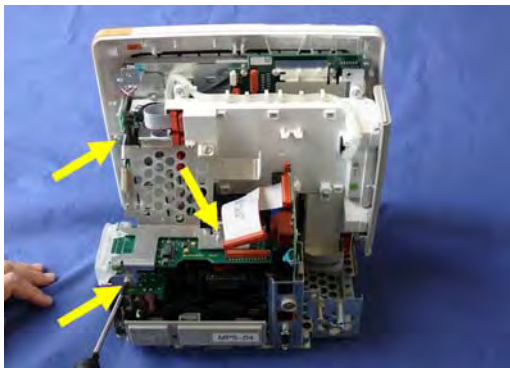



5. Separate the MSL board from the IIT/Bedside Adapter Holder by removing the three screws..

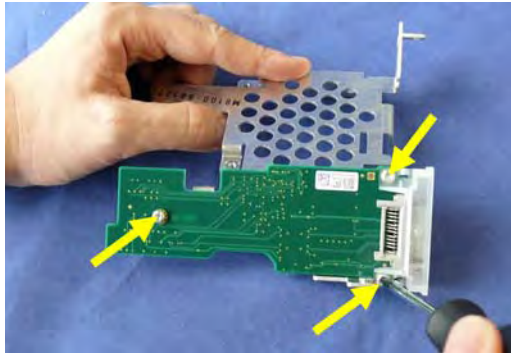

6. Pull off the connector holder by lifting up the hooks.

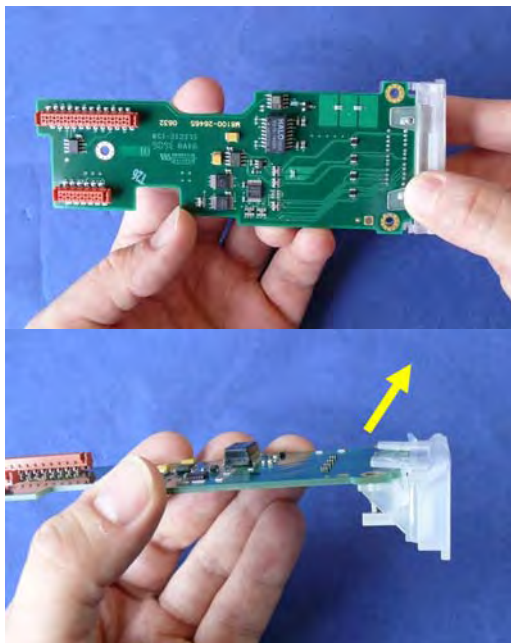

7. For reassembly, perform the above steps in reverse order.

## Removing the Backlight Inverter Board

1. Remove the predictive temperature assembly as described above.
2. Separate the front and back of the monitor as described above.

3. Disconnect the two connectors on the backlight inverter board.

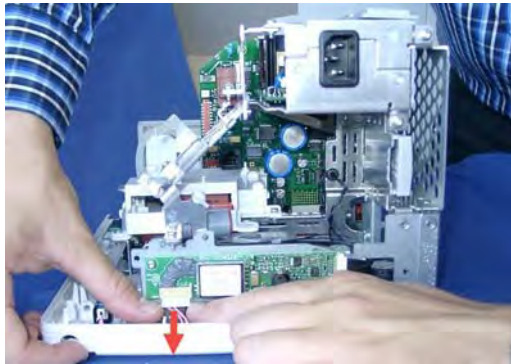

4. Unscrew the two screws on the board and remove the board. Make sure that you also take out the spacers behind the screws.

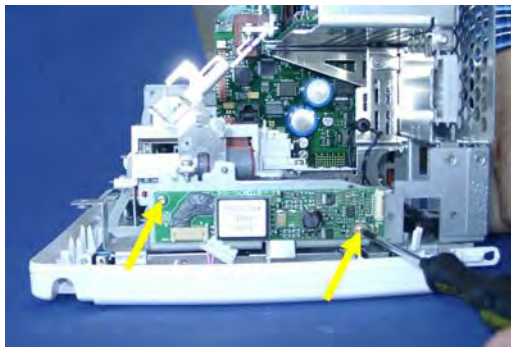

5. For reassembly, perform the above steps in reverse order.

**Reassembly Notes:**

- Make sure that you reinsert the spacers when you screw the backlight inverter board back into place.
- Insert the Backlight tube cable connector correctly into the board and make sure it fits tightly.
- The backlight tube cable must be placed correctly in its holder. Otherwise the touch functionality of the display may be disturbed.



## Removing the Power Supply

1. Remove the predictive temperature assembly as described above.
2. Separate the front and back of the monitor as described above.
3. Remove the IIT/Bedside Adapter Holder as described above.

4. Remove the three screws securing the power supply.

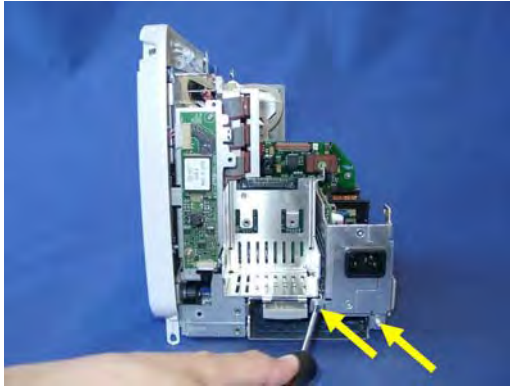

5. Pull out the power supply.

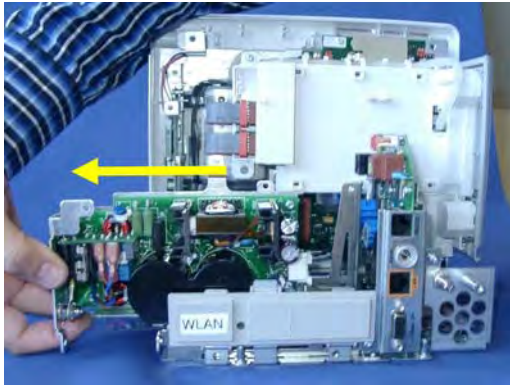

6. For reassembly, perform the above steps in reverse order.

**Reassembly Note:** When reinserting the power supply, slide it carefully into the guiding latches of the metal chassis.

## Removing the System Interface Board

### NOTE

When replacing the system interface board, the monitor must have the serial number and product option reloaded. A support tool is required to perform this task. Please see the Support Tool Instructions for Use document for details on how to load a new serial number.

### NOTE

Removing the system interface board erases the status log of the monitor. Please make sure to save the status log using the support tool before removing the system interface board. Refer to the support tool instructions for use for further details.

1. Remove the predictive temperature assembly as described above.
2. Separate the front and back of the monitor as described above.
3. Remove the IIT/Bedside Adapter Holder as described above.
4. Remove the power supply as described above.
5. Remove the screws securing the system interface board.



6. If you have Microstream CO<sub>2</sub>, you need to unplug the cable between the CO<sub>2</sub> board and the interface board.

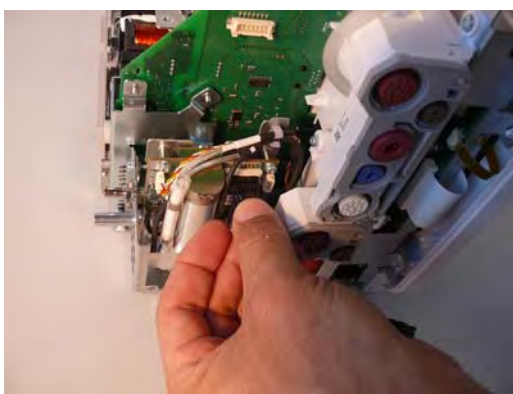
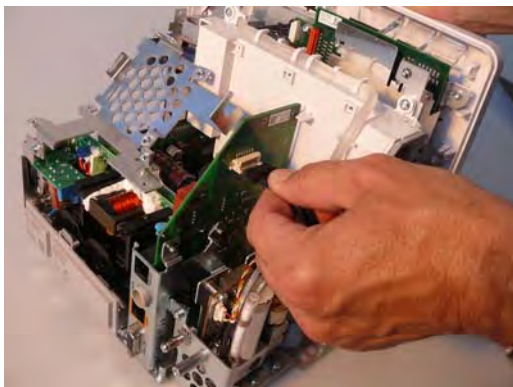

7. Pull out the system interface board.



8. For reassembly, perform the above steps in reverse order.

## Removing the Recorder Board

1. Remove the predictive temperature assembly as described above.
2. Separate the front and back of the monitor as described above.
3. Remove the IIT module or 802.11 Bedside adapter and its holder as described above.
4. Remove Power Supply



5. Remove System Interface Board
6. Unscrew the screws securing the recorder board.

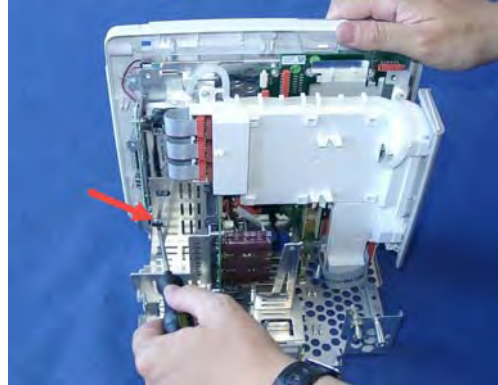

7. Pull out recorder board

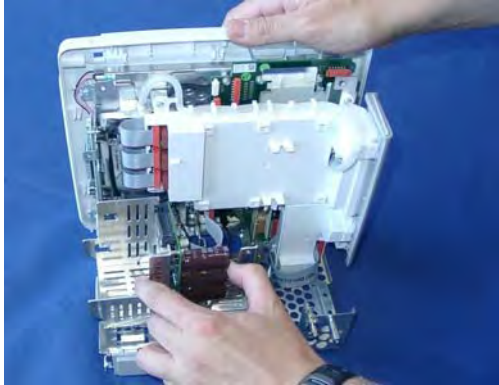

8. Unplug the main board connector from the recorder board.

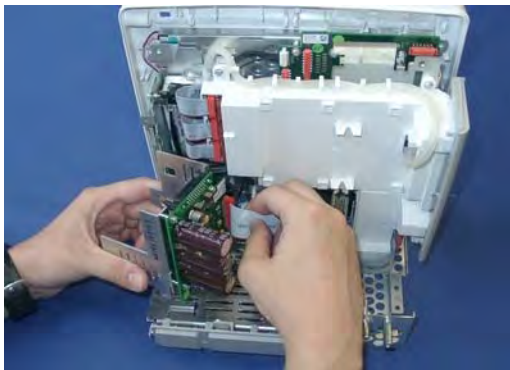

9. Unscrew the recorder board from the recorder assembly.

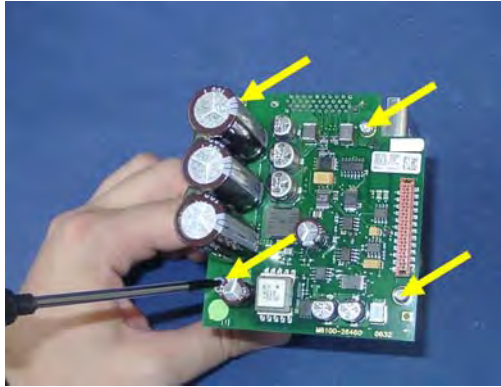

10. For reassembly, perform the above steps in reverse order.

## Removing the Microstream CO2 Assembly

1. Separate the front and back of the monitor as described above.
2. Pull off the Measurement Block Cover by flipping it upwards from the bottom as shown below.

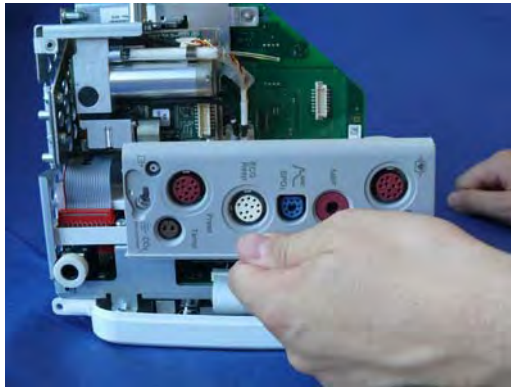

3. Depending on your Front End 1 and 2 options, your monitor should now look similar to this.

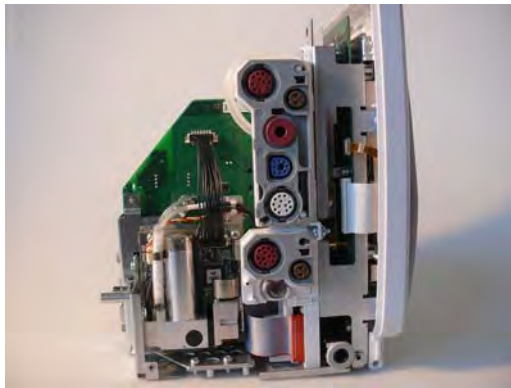



4. If not already done, unplug the cable between the CO2 board and the system interface board. Unplug the other end of the cable from the CO2 board.

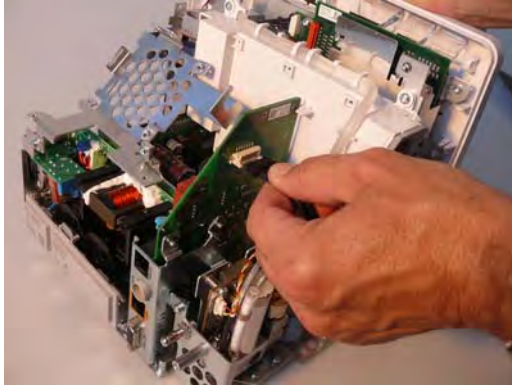

5. Remove the tubings and the cable from their holder.

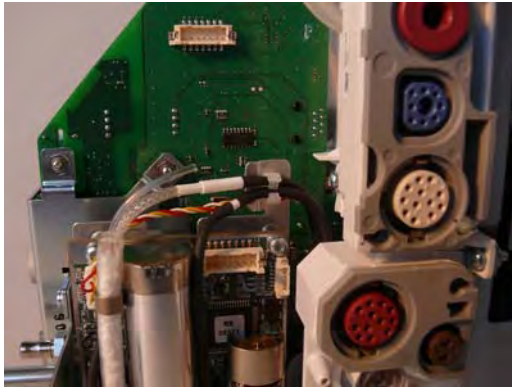

6. Unscrew the CO2 holder from the system interface board.

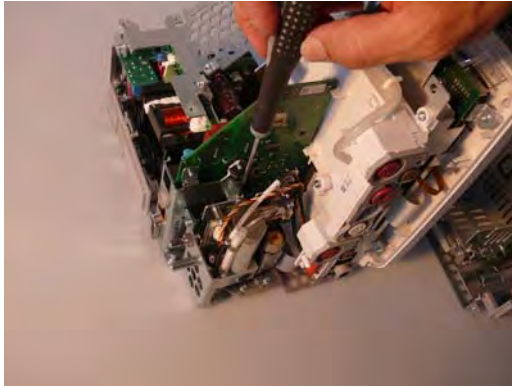

7. Unscrew the CO2 holder from the housing. Monitors with a serial number prefix <DE748 additionally use a screw/nut combination to secure the CO2 holder. Make sure that you do not lose the screws or nuts. Monitors with serial no. prefix DE748 or higher already have the necessary screw threads in the housing and therefore do not require additional nuts.

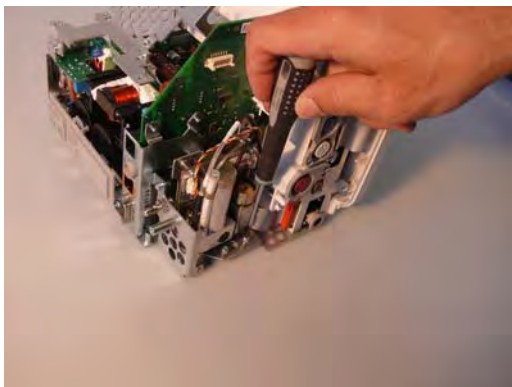

8. Remove the CO2 tubing from the CO2 inlet of the Front End 2 housing.

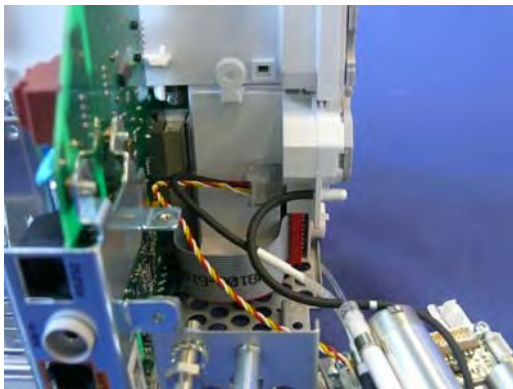

9. Remove the CO2 board connector from the slot in the Front End 2 housing using the Luer Remover.

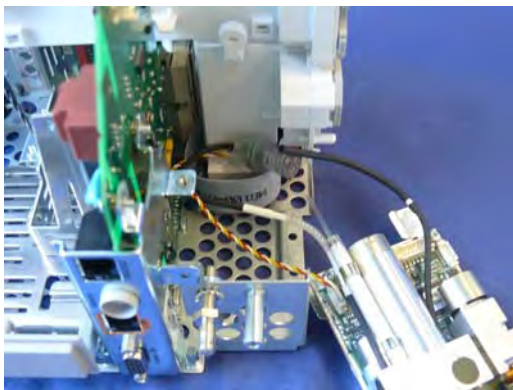
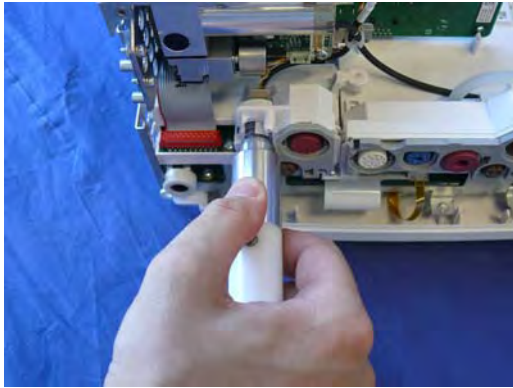

10. Remove the CO2 board from the CO2 board holder by disassembling the holder.

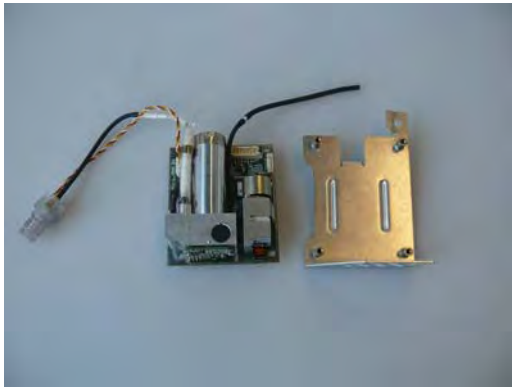
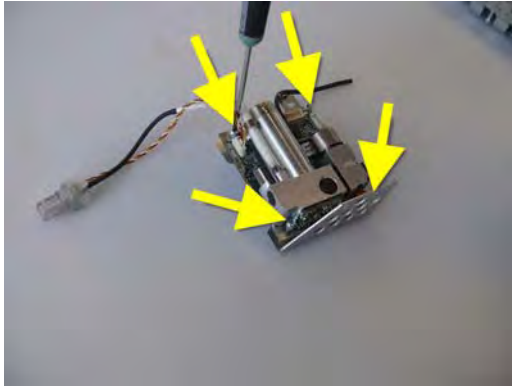

**Reassembly Note:** Make sure the CO2 connector is inserted into the slot in the Front End 2 housing with the colored cable facing you.

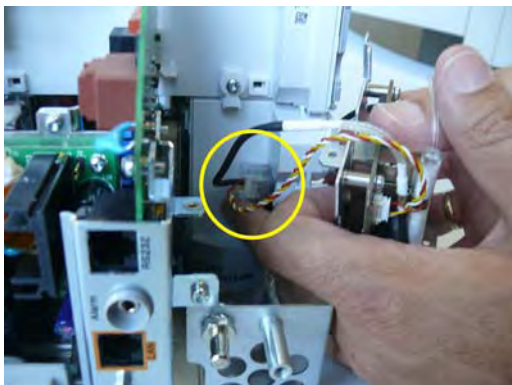



11. Reassemble by performing the above steps in reverse order.

## Removing the Measurement Block

1. Remove the predictive temperature assembly as described above.
2. Separate the front and back of the monitor as described above.
3. Remove the IIT module or 802.11 Bedside adapter and its holder as described above.
4. Remove Power Supply
5. Remove System Interface Board
6. Remove the recorder board as described above.
7. Remove the Microstream CO2 Assembly as described above.
8. If not already done in the previous step, pull off the Measurement Block Cover by flipping it upwards from the bottom as shown below.



9. Unplug the ribbon connector from the Front End 2 measurement block to the measurement board.

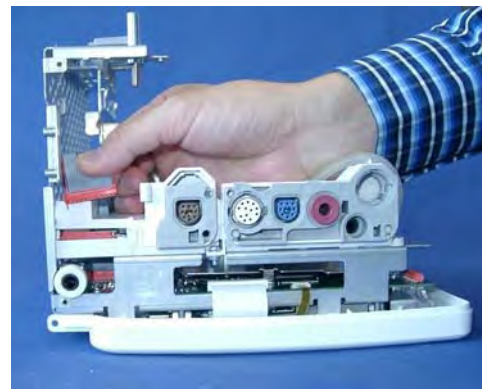

10. Unscrew the screws from the Front End 2 measurement board

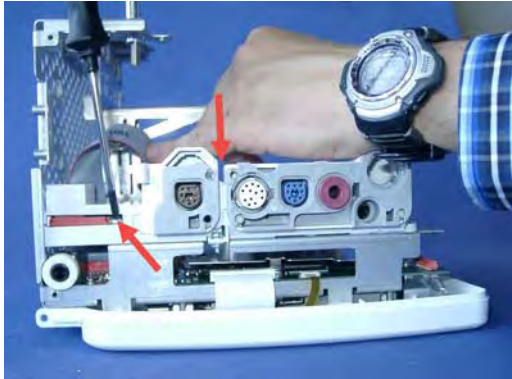

11. Lift off the Front End 2 measurement block.

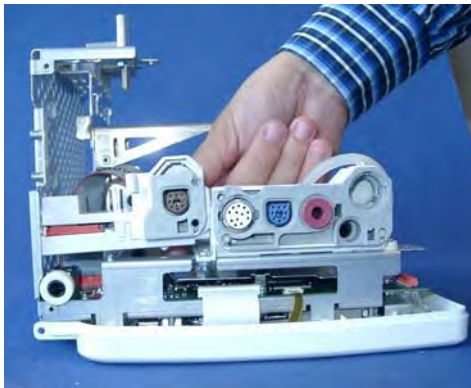

12. Replace the Front End 2 measurement block, if necessary.
13. Exchange Front End 2 housings contain a CO2 inlet which may not fit with your Front End 2 Measurement block cover. This may be the case if your monitor was originally not equipped with Microstream CO2.  
If you have the old version without the CO2 inlet, separate the Front end 2 measurement block housing of the exchange part as shown below.



14. Replace the exchange Front End 2 measurement block top cover with the old version without CO2 inlet (either the old one or the one provided with the exchange part).



15. Unplug the end of the NBP tubing and remove the tubing from its holders.



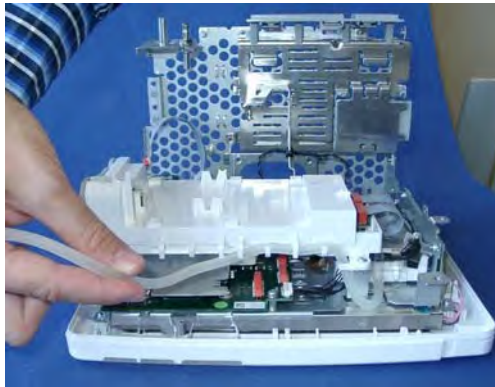

16. Unplug the connectors from the Front End 1 measurement block.



17. Unscrew the screws securing the Front End 1 measurement block and remove the measurement block.

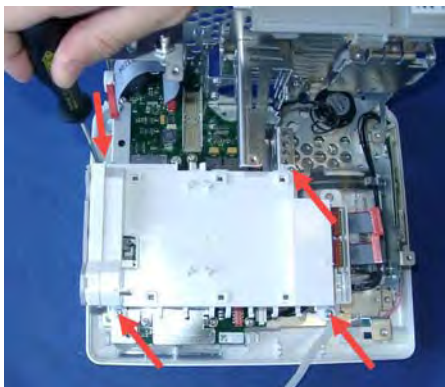

18. For reassembly, perform the above steps in reverse order.

## Removing the NBP Pump

1. Remove the predictive temperature assembly as described above.
2. Separate the front and back of the monitor as described above.
3. Remove the IIT module or 802.11 Bedside adapter and its holder as described above.
4. Remove Power Supply
5. Remove System Interface Board
6. Remove the recorder board as described above.
7. Remove the Microstream CO2 Assembly as described above.
8. Remove the measurement block as described above.
9. Remove the black backlight cables from their holders in the NBP pump cage.



10. Unplug the backlight connector from the main board.

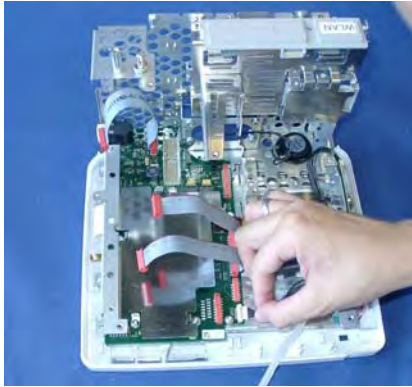

11. Unscrew the three screws and remove the metal sheet from the main board.

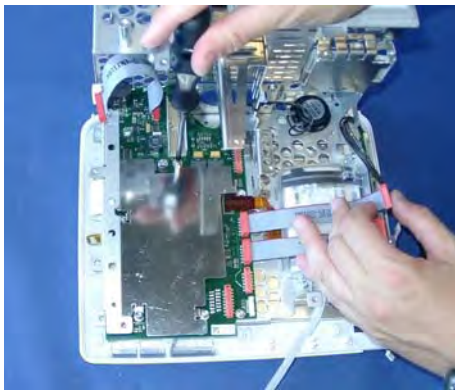

12. **Carefully** unplug the NBP pump connector from the main board by holding the connector on its sides and gently pulling up.



13. Unscrew the screws securing the NBP pump cage.



14. Remove the NBP pump cage and the NBP pump.
15. Remove the two plastic tubings from the new NBP pump and insert the new pump.



16. For reassembly, perform the above steps in reverse order.

**Reassembly Notes:**

- Make sure that the NBP tubing is reinserted and correctly fitted into its position before reinstalling the NBP pump.
- Insert the NBP pump cage in the correct position, so the NBP tubing fits under the rounded cover and the NBP pump cages sits correctly on the metal frame domes.
- When reattaching the metal sheet to the main board do not overtighten the screws.

**NOTE**

If the NBP pump is replaced you need to perform an NBP Accuracy test afterwards.

# Removing the Main Board

## NOTE

- When replacing the main board, the monitor must be reloaded with the software, purchased options and settings. A support tool is required to perform these tasks. Please see the Support Tool Instructions for Use document for details on how to load software, options and settings.
- When upgrading or cloning an MP5 monitor, the support tool may display the following text string:  
"A faulty main board is detected. Please replace the main board. For further details contact your local Philips Support."  
**Upgrading and cloning processes are still possible and will continue.**  
This message is due to the fact that the support tool includes a new feature which checks the reliability of a main board component which is suspected to be the cause of an increased future failure rate of the main board. Only a few monitors contain this potentially faulty main board component. If the support tool detects an affected main board during any upgrade or cloning activity, replace the affected main board. After the main board is replaced, reload the software and configuration of the monitor. Please order the exchange main board M8100-68450 - 12NC: 451261019011

## NOTE

You must perform a touchscreen calibration with the support tool after a main board exchange.

## NOTE

Before exchanging the main board, retrieve the status log from the monitor with the support tool. Please include a status log printout when returning the defective main board

1. Remove the predictive temperature assembly as described above.
2. Separate the front and back of the monitor as described above.
3. Remove the Short Range Radio Interface as described above.
4. Remove the IIT module or 802.11 Bedside adapter and its holder as described above.
5. Remove the Power Supply as described above.
6. Remove the System Interface Board as described above.
7. Remove the recorder board as described above.
8. Remove the Microstream CO2 Assembly as described above.
9. Remove the measurement block as described above.



10. Unplug the speaker cables from the main board.



11. Unplug the touch screen and display cable connectors from the main board. Unlock the connector locks by pulling the connector lock mechanism forwards.

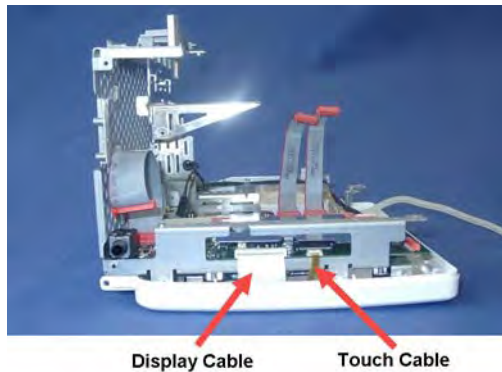

12. Unscrew the three screws and remove the metal sheet from the main board.

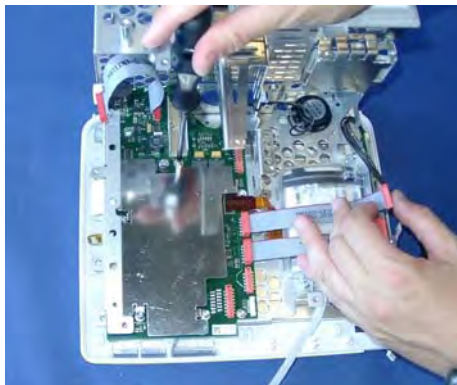

- Carefully unplug the NBP pump connector from the main board by holding the connector on its sides and gently pulling up.

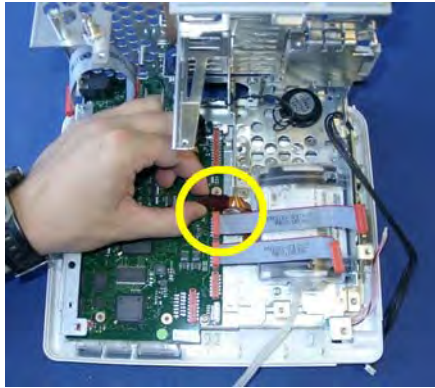

- Remove the remaining screws securing the main board. Then take out the main board.



- For reassembly, perform the above steps in reverse order.

**Reassembly Notes:**

- Reattach the main board with the two screws not used for the metal sheet first. When reattaching the metal sheet to the main board do not overtighten the screws.
- Make sure that the display and touch cables are inserted correctly and the retainers are locked.

**NOTE**

When the main board is replaced, you need to perform a NBP accuracy check afterwards.

## Removing the Touch Assembly

1. Remove the predictive temperature assembly as described above.
2. Separate the front and back of the monitor as described above.
3. Remove the antenna as described above.
4. Unplug the touch cable from the main board.



5. Unscrew the four screws securing the touch assembly.

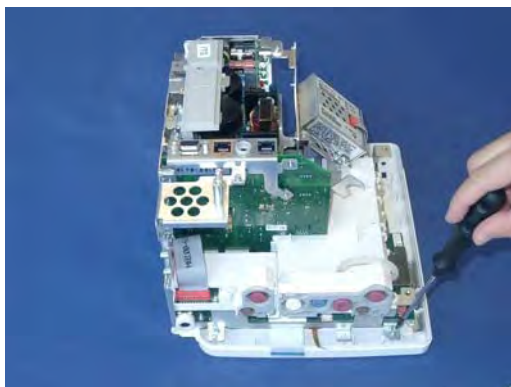
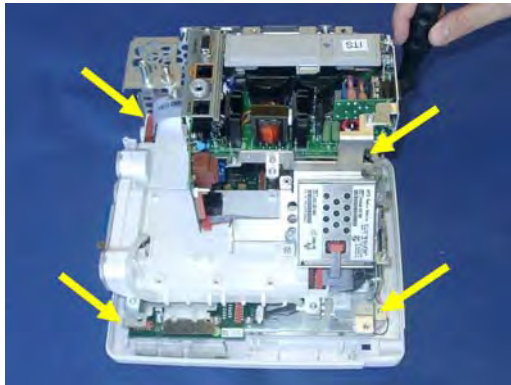



6. Separate the touch assembly from the unit.



7. For reassembly, perform the above steps in reverse order.
8. After reassembly, recalibrate the touchscreen.

## Removing the Loudspeaker

1. Remove the predictive temperature assembly as described above.
2. Separate the front and back of the monitor as described above.
3. Remove the IIT module or 802.11 Bedside adapter and its holder as described above.
4. Remove Power Supply
5. Remove System Interface Board
6. Remove the recorder board as described above.
7. Remove the touch assembly as described above.
8. Disconnect the speaker connector from the main board.
9. Press the clips of the loudspeaker to the inside and remove the speaker as shown below.



10. For reassembly, perform the above steps in reverse order.

## Removing the Power Button and LED Assembly

1. Remove the predictive temperature assembly as described above.
2. Separate the front and back of the monitor as described above.
3. Unscrew the screw securing the Power Button LED Assembly.

4. From the front, push the assembly to the side and then remove it.





5. For reassembly, perform the above steps in reverse order.

## Removing the LCD Panel

1. Remove the predictive temperature assembly as described above.
2. Separate the front and back of the monitor as described above.
3. Remove the touch assembly as described above.
4. Unplug the display cable from the main board.
5. Unplug the backlight tube cable from the backlight inverter board.
6. Unscrew the four screws securing the LCD panel.



7. Separate the LCD panel from the metal chassis.

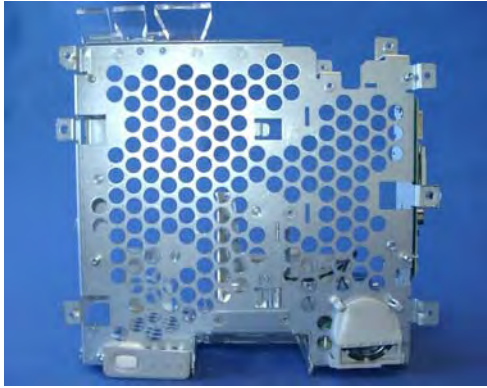

**NOTE**

Avoid touching the screen of the LCD panel. If necessary, remove fingerprints and dust from the screen with a soft tissue.

8. For reassembly, perform the above steps in reverse order.

**Reassembly Note:** Connect the flat display cable before reassembling the LCD panel.

## Exchanging the Backlight

1. Remove the predictive temperature assembly as described above.
2. Separate the front and back of the monitor as described above.
3. Remove the touch assembly as described above.
4. Remove the LCD panel as described above.
5. Push back the snap securing the backlight with a screwdriver.



6. Pull out the backlight.

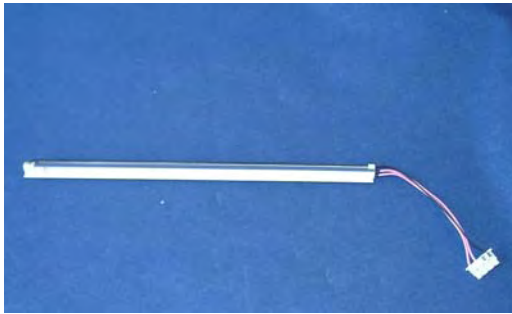
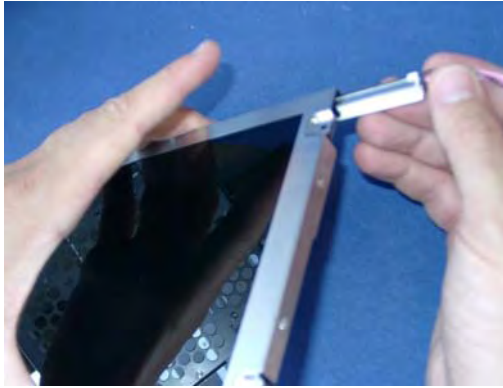

7. For reassembly, perform the above steps in reverse order.



## Modifying the Nurse Call Relay

Some customers may want to have an Open-On-Alarm relay instead of a Closed-On-Alarm for their Nursecall system. Using this installation note, qualified Philips service personnel can modify the MP5 system interface board, part number M8100-67580 (4512 610 19281).

**The modification should be done only on request, in the field. All factory supplied MP5 system interface boards or MP5 monitors have the original board including the Close-On-Alarm Relay.**

To make the Open-On-Alarm relay modification, complete the following steps:

1. Unsolder the existing SMD Resistor shown in the pictures below on the back of the system interface board:

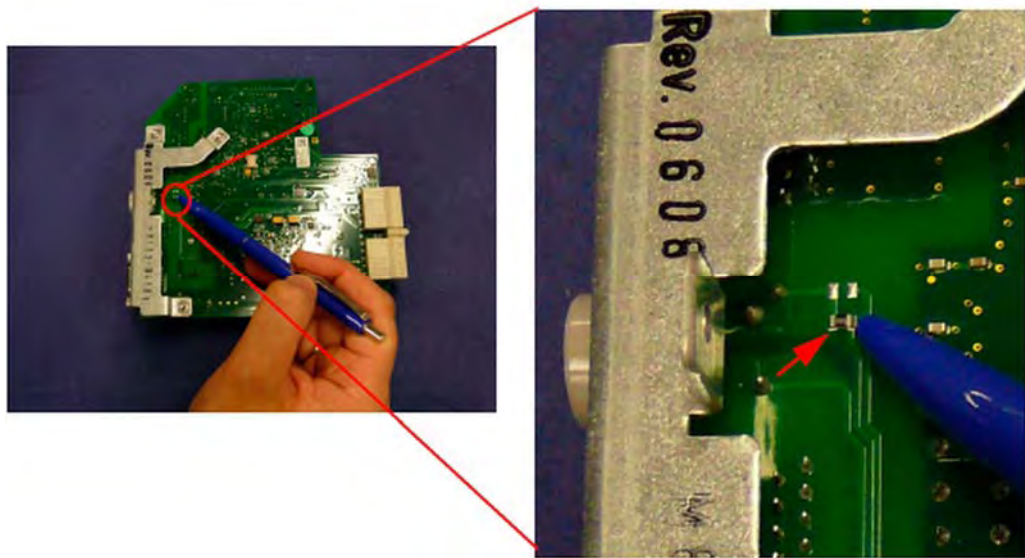

2. Make sure that no electrical connection remains between the formerly connected solder points. Verify this by using an Ohmmeter. Expected Result: High Impedance ( $\approx 10k\Omega$ ).
3. Build a new connection to the Open-On-Alarm contact as shown below. Using a piece of wire and solder, connect the two solder points on the back of the circuit board above the original soldered joint as illustrated in the following photographs:

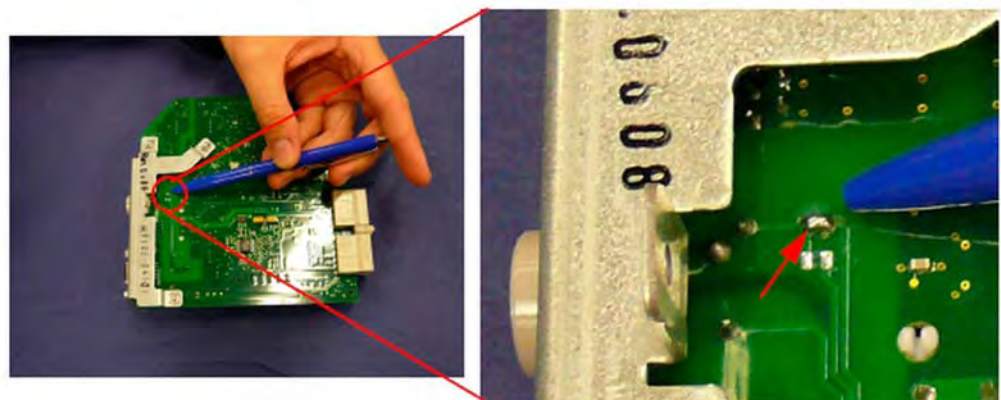

4. Make sure that there is an electrical connection between the soldered points. Verify this by using an Ohmmeter. Expected result: Low Impedance( $\leq 1\Omega$ ).
5. Attach a label to the instrument next to the output and, using permanent black or blue ink, add localized text similar to: "Nursecall is Open-On-Alarm Relay" or "Nursecall is open" Inform the customer that the specification of the Nurse Call Relay has been changed from active closed contact to active open contact.

### Verification Procedure

Perform the following tests:

1. Power On Test.
2. Nursecall Performance Test (*Modified MP5 Nurse Call Alarm Relay Test* (on page 95)).
3. Safety Test.

Note that you must document the modification for a particular unit including the verifications.



---

# Parts

This section lists the replacement and exchange parts for the following Philips IntelliVue Patient Monitoring System components:

- *MP5/MP5T Parts* (on page 202)
- *External Display Part Numbers (not for MP5T)* (on page 214)

# MP5/MP5T Parts

## NOTE

For part numbers of interconnecting cables, please consult the *Site Preparation and Installation Instructions* sections. For network-related parts, please see the M3185A Philips Clinical Network documentation.

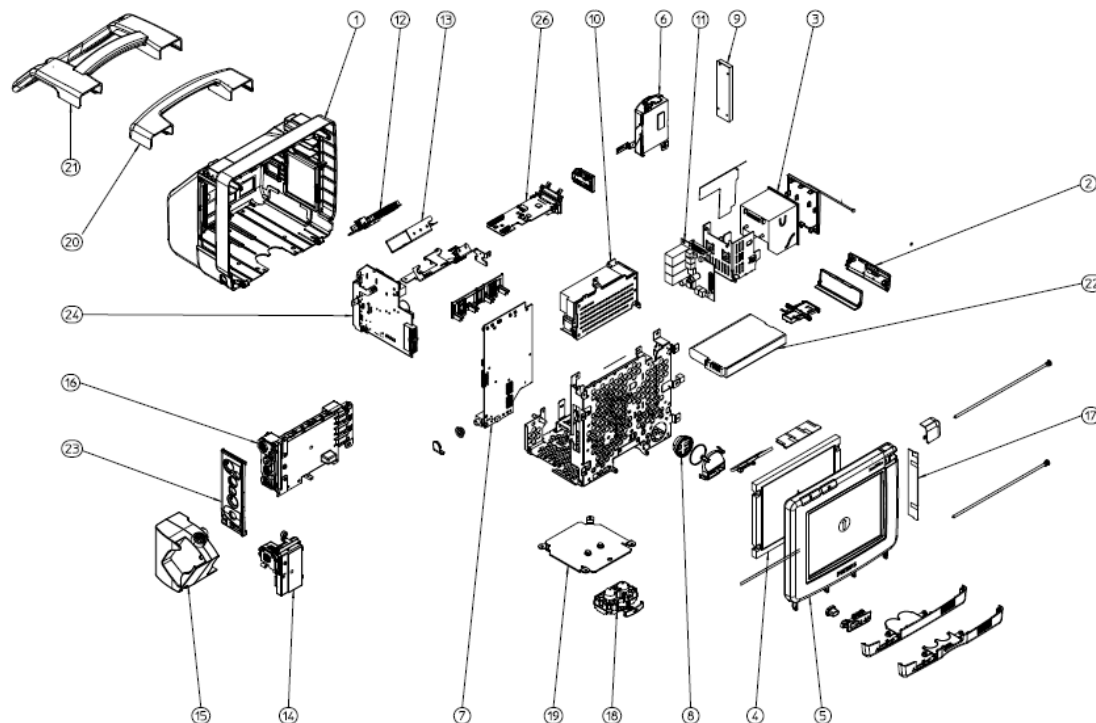

## Exchange and Replacement Parts

| No. in Diagram | Exchange Part Number<br>12NC Part No. | New Part Number<br>12NC Part No. | Description           |
|----------------|---------------------------------------|----------------------------------|-----------------------|
| 1              | n/a                                   | M8100-60300<br>451261018941      | MP5 Assy Housing Rear |
| 2              | n/a                                   | M8100-40301<br>451261018951      | MP5 Door Battery      |
| 3              | n/a                                   | M8001-60101<br>451261018961      | MP5 GSI TPH Recorder  |

| No. in Diagram | Exchange Part Number<br>12NC Part No. | New Part Number<br>12NC Part No. | Description  |
|----------------|---------------------------------------|----------------------------------|--|
| 4              | n/a                                   | 2090-0984<br>451261018971        | MP5 TFT LCD 8.4"                                       |
| 5              | n/a                                   | M8105-60010<br>451261018981      | MP5 Bezel Touch Assembly                               |
| 6              | n/a                                   | M3000-60503<br>451261018991      | MP5 NBP Assembly                                       |
| 26             | n/a                                   | M8100-66565<br>451261021171      | MP5 MSL Board  |
| 7              | M8100-68450<br>451261019011           | n/a                              | MP5 Main Board   |
| 8              | n/a                                   | M8100-61403<br>451261019021      | MP5 Speaker Assembly                                   |
| n/a            | n/a                                   | 2090-0987<br>451261017041        | MP5 Backlight Lamp Assembly<br>for TFT LCD (one piece) |
| 9              | n/a                                   | 0950-9086<br>451261019031        | MP5 Backlight Inverter for 8.4"                        |
| 10             | n/a                                   | M8105-60001<br>451261019981      | MP5 Power Supply                                       |
| 11             | n/a                                   | M8100-66560<br>451261019051      | MP5 Recorder Board                                     |
| 12             | n/a                                   | M8096-67501<br>451261019061      | MP5 WLAN Assy  |
| 13             | M4840-68708<br>451261009041           | n/a                              | IIT Module (US)  |
| 13             | 453564053321                          | n/a                              | IIT Module (Non-US)                                    |
| n/a            | n/a                                   | 453564107681                     | SRR Board  |
| 16             | M8105-68040<br>451261019081           | n/a                              | MP5 FE ECG/NBP/SpO2                                    |
| 16             | M8105-68042<br>451261019101           | n/a                              | MP5 FE ECG/NBP/SPO2/Inv.<br>Press/Temp)                |
| 16             | M8105-68044<br>451261019121           | n/a                              | MP5 FE ECG/NBP/SPO2/CO2 )                              |
| 16             | M8105-68046<br>451261019131           | n/a                              | MP5 FE<br>ECG/NBP/SPO2/TAAP)                           |
| 16             | M8105-68050<br>451261019151           | n/a                              | MP5 FE ECG/NBP/SpO2 -<br>12Lead                        |
| 16             | M8105-68052                           | n/a                              | MP5 FE ECG/NBP/SpO2/Inv.                               |

| No. in Diagram | Exchange Part Number<br>12NC Part No. | New Part Number<br>12NC Part No. | Description   |
|----------------|---------------------------------------|----------------------------------|---|
|                | 451261019171                          |                                  | Press/Temp - 12Lead                                   |
| 16             | M8105-68054<br>451261019191           | n/a                              | MP5 FE ECG/NBP/SpO2/CO2 - 12Lead                      |
| 16             | M8105-68056<br>451261019211           | n/a                              | MP5 FE ECG/NBP/SpO2/TAAP - 12Lead                     |
| 14             | n/a                                   | M8105-60560<br>451261019221      | MP5 FE2 pred. Temp                                    |
| n/a            | n/a                                   | 989803143391                     | Pred. Temp rectal probe                               |
| n/a            | n/a                                   | 989803143381                     | Pred. Temp. oral probe                                |
| n/a            | n/a                                   | M4823A<br>9898031xxxxx           | Probe Cover (250 pcs.)                                |
| 14             | n/a                                   | M8105-60562<br>451261019231      | MP5 FE2 Inv. Press./Temp                              |
| 16             | 453564107701                          | n/a                              | MP5 FE NBP/SpO2                                       |
| 16             | n/a                                   | 453564107711                     | MP5 FE2 Inv. Press./Temp (mCO2 ready)                 |
| 16             | n/a                                   | M8105-60536<br>451261021131      | MP5T FE NBP/TAAP                                      |
| 16             | n/a                                   | M8105-60538<br>451261021151      | MP5T FE NBP/SpO2/TAAP                                 |
| 15             | n/a                                   | M8105-64100<br>451261019241      | MP5 pred. Temp Housing Kit                            |
| 15             | n/a                                   | M8105-60500<br>451261019251      | MP5 pred. Temp Assy                                   |
| 24             | n/a                                   | M8100-67582<br>451261019261      | MP5 I/F Assy LAN, Video                               |
| 24             | n/a                                   | M8100-67581<br>451261019271      | MP5 I/F Assy LAN, Battery                             |
| 24             | n/a                                   | M8100-67580<br>451261019281      | MP5 I/F Assy LAN, Video, Battery, RS-232, Nurse Call  |
| 24             | 453564107731                          | n/a                              | MP5 mCO2 Assy   |
| 24             | n/a                                   | M8100-67584<br>453564112891      | MP5 I/F LAN, Battery, mCO2                            |
| 24             | n/a                                   | M8100-67583<br>453564112881      | MP5 I/F LAN, Video, Battery, RS-232, Nurse Call, mCO2 |
| 17             | n/a                                   | M8100-66490<br>451261019291      | MP5 Triband Antenna                                   |

| No. in Diagram | Exchange Part Number<br>12NC Part No. | New Part Number<br>12NC Part No. | Description                                  |
|----------------|---------------------------------------|----------------------------------|--|
| 18             | n/a                                   | M8100-60800<br>451261019331      | MP5 Assembly Quick Mount                     |
| n/a            | n/a                                   | M8000-64100<br>451261001381      | MECHASY Kit Table Mount                      |
| 19             | n/a                                   | M8105-60310<br>451261019401      | MP5 Mounting Adapter                         |
| 20             | n/a                                   | M8100-44901<br>451261019351      | MP5 Handle Standard                          |
| 21             | n/a                                   | M8105-60112<br>451261023691      | MP5 Handle Bedhanger non-slip                |
| 22             | n/a                                   | M4605A<br>989803135861           | Battery 10.8V 6Ah LiIon                      |
| n/a            | n/a                                   | 989803143481                     | PWD Tether Cable (equal to M2636-60030) 0.5m |
| n/a            | n/a                                   | 989803146911                     | MP5 Tether Cable 2m                          |
| n/a            | n/a                                   | 989803153021                     | MP2/X2/MP5 Rollerstand                       |

### Tools

| Part Number<br>12NC Part No. | Description                    |
|------------------------------|--------------------------------|
| 453564033691                 | Calibration Key                |
| 453564117411                 | MP5 mCO2 Luer Remover          |
| M2267A<br>989803106081       | Calibration Regulator          |
| M1026-60144<br>453563230731  | AGM Electronic Mass FlowMeter  |
| 15210-64010<br>989803100841  | Gas Cal 1 cylinders for tcpCO2 |

| Part Number<br>12NC Part No. | Description                              |
|------------------------------|--|
| 15210-64020<br>989803100851  | Gas Cal 2 cylinders for tcpCO2           |
| 13907A<br>989803100361       | Calibration Tube Assembly                |
| M2505A<br>989803142701       | Gas Cylinder Regulator                   |
| M2506A<br>989803142711       | Verification Gas                         |
| M2776A<br>989803144561       | Straight Sample Line                     |
| M3199-60101<br>453563337371  | 3ft UTP crossover cable orange,<br>0.9m  |
| M3199-60102<br>453563337381  | 12ft UTP crossover cable orange,<br>3.6m |

**Small Parts Kit 1 Contents (misc.) - 453564107751:**



| Description                    | Quantity | No. in Photo |
|--------------------------------|----------|--------------|
| Light pipes                    | 1        | 1            |
| SRL Cover                      | 1        | 2            |
| Recorder Cover                 | 1        | 3            |
| Cover battery opening          | 1        | 4            |
| Sound Tube                     | 1        | 5            |
| O-Ring Loudspeaker             | 1        | n/a          |
| Front Cover (with Quick mount) | 1        | 7            |
| Front Cover (w/o Quick mount)  | 1        | 8            |
| Power On / Off Button          | 1        | 9            |
| Holder Power Button Assy       | 1        | 9            |

| Description                | Quantity | No. in Photo |
|----------------------------|----------|--------------|
| White Pins                 | 2        | 10           |
| Screw Torx M2.5*8          | 6        | 11           |
| Screw Torx M3*8 w/ washer  | 10       | 11           |
| Screw Torx M4*25 w/ washer | 8        | 11           |
| Screw Torx M4*12 w/ washer | 4        | 11           |
| Screw Torx M3*12           | 4        | 11           |
| Screw Torx K30*8           | 4        | 11           |
| Screw K25*8                | 7        | 11           |
| Screw K25*5 (black)        | 3        | 11           |
| Foot                       | 4        | 12           |
| Pin for Recorder Cover     | 1        | 13           |
| MSL Holder                 | 1        | 14           |
| Frame ECG Out Connector    | 1        | 15           |

#### Small Parts Kit 2 Contents (cables) - 453564107761:



| Description                               | Quantity | No. in Photo |
|---|----------|--------------|
| TFT Display Flex Cable (internal)         | 1        | 1            |
| FE cables (internal)                      | 3        | 2            |
| FE2 cable                                 | 1        | 3            |
| Backlight inverter cable (internal)       | 1        | 4            |
| Recorder cable (internal)                 | 1        | 5            |
| WLAN Assembly cable (internal)            | 1        | 6            |
| IIT Assy cable (internal)                 | 1        | 7            |
| WLAN & IIT Antenna cable, coax (internal) | 1        | 8            |

| Description                 | Quantity | No. in Photo |
|-----------------------------|----------|--------------|
| Holder IIT Antenna cable    | 2        | 9            |
| WLAN bracket                | 1        | 10           |
| MSL Cable                   | 1        | 11           |
| Flex Cable Predictive Temp. | 1        | 12           |
| SRR Cable                   | 1        | 13           |
| mCO2 Cable                  | 1        | 14           |

**Small Parts Kit 3 Contents (corner covers) - 453564107771:**

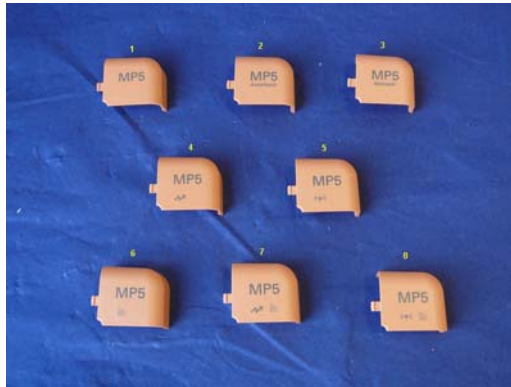

| Description                  | Quantity | No. in Photo |
|------------------------------|----------|--------------|
| MP5 Cover Brand              | 1        | 1            |
| MP5 Cover Brand Anesthesia   | 1        | 2            |
| MP5 Cover Brand Neonatal     | 1        | 3            |
| MP5 Cover Brand IIT          | 1        | 4            |
| MP5 Cover Brand WLAN         | 1        | 5            |
| IV-MP5 Cover Brand SRR       | 1        | 6            |
| IV-MP5 Cover Brand IIT + SRR | 1        | 7            |
| IV-MP5 Cover Brand WLAN +SRR | 1        | 8            |

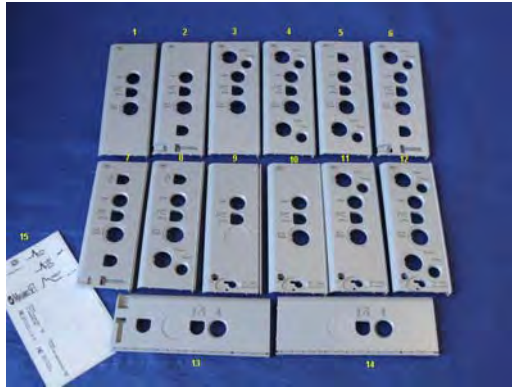

**MP5 FE Cover Kit , text - 453564107781:**

| Description                                     | Quantity | No. in Photo |
|---|----------|--------------|
| MP5 FE Cvr txt ECG/NBP/SpO2                     | 1        | 1            |
| MP5 FE Cvr txt<br>ECG/NBP/SpO2/predTemp         | 1        | 2            |
| MP5 FE Cvr txt<br>ECG/NBP/SpO2/BP/Temp          | 1        | 3            |
| MP5 FE Cvr txt<br>ECG/NBP/SpO2/2xBP/2xTemp      | 1        | 4            |
| MP5 FE Cvr txt<br>ECG/NBP/SpO2/BP/Temp/CO2      | 1        | 5            |
| MP5 FE Cvr txt<br>ECG/NBP/SpO2/BP/Temp/predTemp | 1        | 6            |
| MP5 FE Cvr txt<br>ECG/NBP/SpO2/TAAP/predTemp    | 1        | 7            |
| MP5 FE Cvr txt<br>ECG/NBP/SpO2/TAAP/BP/Temp     | 1        | 8            |
| IV-MP5 Cvr txt NBP/SpO2/mCO2                    | 1        | 9            |
| IV-MP5 Cvr txt ECG/NBP/SpO2/mCO2                | 1        | 10           |
| IV-MP5 Cvr txt<br>ECG/NBP/SpO2/BP/Temp/mCO2     | 1        | 11           |
| IV-MP5 Cvr txt<br>ECG/NBP/SpO2/2xBP/2xTemp/mCO2 | 1        | 12           |
| IV-MP5 Cvr txt NBP/SpO2/Pred.Temp               | 1        | 13           |
| IV-MP5 Cvr txt NBP/SpO2                         | 1        | 14           |
| MP2/X2/MP5 Label Sheet incl. SRR                | 1        | 15           |

**MP5 FE Cover Kit , symbol - 453564107791:**

| Description                                      | Quantity | No. in Photo |
|--|----------|--------------|
| MP5 FE Cvr symb ECG/NBP/SpO2                     | 1        | 1            |
| MP5 FE Cvr symb<br>ECG/NBP/SpO2/predTemp         | 1        | 2            |
| MP5 FE Cvr symb<br>ECG/NBP/SpO2/BP/Temp          | 1        | 3            |
| MP5 FE Cvr symb<br>ECG/NBP/SpO2/2xBP/2xTemp      | 1        | 4            |
| MP5 FE Cvr symb<br>ECG/NBP/SpO2/BP/Temp/CO2      | 1        | 5            |
| MP5 FE Cvr symb<br>ECG/NBP/SpO2/BP/Temp/predTemp | 1        | 6            |
| MP5 FE Cvr symb<br>ECG/NBP/SpO2/TAAP/predTemp    | 1        | 7            |
| MP5 FE Cvr symb<br>ECG/NBP/SpO2/TAAP/BP/Temp     | 1        | 8            |
| IV-MP5 Cvr symb NBP/SpO2/mCO2                    | 1        | 9            |
| IV-MP5 Cvr symb<br>ECG/NBP/SpO2/mCO2             | 1        | 10           |
| IV-MP5 Cvr symb<br>ECG/NBP/SpO2/BP/Temp/mCO2     | 1        | 11           |
| IV-MP5 Cvr symb<br>ECG/NBP/SpO2/2xBP/2xTemp/mCO2 | 1        | 12           |
| IV-MP5 Cvr symb NBP/SpO2/Pred.Temp               | 1        | 13           |
| IV-MP5 Cvr symb NBP/SpO2                         | 1        | 14           |
| MP2/X2/MP5 Label Sheet incl. SRR                 | 1        | 15           |

**MP5T FE Cover Kit - M8105-64006 (12NC: 451261021161):**

| Description                                | Quantity | No. in Photo |
|--|----------|--------------|
| MP5T FE Cvr txt NBP/TAAP                   | 1        | 1            |
| MP5T FE Cvr txt NBP/SpO2/TAAP              | 1        | 2            |
| MP5T FE Cvr txt<br>NBP/SpO2/TAAP/predTemp  | 1        | 3            |
| MP5T FE Cvr symb NBP/TAAP                  | 1        | 4            |
| MP5T FE Cvr symb NBP/SpO2/TAAP             | 1        | 5            |
| MP5T FE Cvr symb<br>NBP/SpO2/TAAP/predTemp | 1        | 6            |
| MP5T Cover Brand                           | 1        | 7            |
| MP5T Cover Brand SRR                       | 1        | 8            |
| Cover ECG Synch.p                          | 1        | 9            |

**5/6 Lead vs. 12 Lead ECG Capability Identification****MP5 with Rev. E**

There is no visible mark on the MP5 housing that indicates whether or not the ECG 12-lead option is enabled.

The Front End 1 part number of the MP5 (located on the label on the white housing cover of the Front End 1) indicates the ECG 12-lead option. The following table lists the respective parts offering 12-lead support.

| Reference Part No. on FE1 Cover | 12NC         | Part No. Exchange | Part Description                   |
|---------------------------------|--------------|-------------------|------------------------------------|
| M8105-60050/<br>M8105-68050     | 451261019151 | M8105-68050       | MP5 exch. FE ECG/NBP/SpO2 - 12Lead |

|                              |              |             |   |
|------------------------------|--------------|-------------|---|
| M8105-60052/<br>M8105-68052  | 451261019171 | M8105-68052 | MP5 exch. FE ECG/NBP/SpO2/BP/Temp -<br>12Lead |
| M8105-60054/<br>M8105-68054  | 451261019191 | M8105-68054 | MP5 exch. FE ECG/NBP/SpO2/CO2 -<br>12Lead     |
| M8105-60056/<br>M81050-68056 | 451261019211 | M8105-68056 | MP5 exch. FE ECG/NBP/SpO2/TAAP -<br>12Lead    |

For the support part numbers of the Front End 1 offering 5-lead support (and 6-lead support running with ECG Firmware Rev. D.02.02 and Monitor SW Rev. F.xx.xx) refer to the table below.

| Reference<br>Part No. on<br>FE1 Cover | 12NC         | Part No.<br>Exchange | Part Description                  |
|---------------------------------------|--------------|----------------------|-----------------------------------|
| M8105-60040/<br>M8105-68040           | 451261019081 | M8105-68040          | MP5 exch. FE ECG/NBP/SpO2         |
| M8105-60042/<br>M8105-68042           | 451261019101 | M8105-68042          | MP5 exch. FE ECG/NBP/SpO2/BP/Temp |
| M8105-60044/<br>M8105-68044           | 451261019121 | M8105-68044          | MP5 exch. FE ECG/NBP/SpO2/CO2     |
| M8105-60046/<br>M8105-68046           | 451261019131 | M8105-68046          | MP5 exch. FE ECG/NBP/SpO2/TAAP    |

Additionally, the following procedure can be used to verify whether or not the ECG 12-lead option is enabled:

1. Power on the MP5 without an ECG cable attached.
2. Open the ECG menu.
3. Select Lead II as primary lead.
4. Check the selection list for the secondary lead; if all V leads (V1 - V6) are visible and selectable, the MP5 has the 12-Lead option.

### MP5 with Rev. F and higher

Beginning with Software Revision F, the ECG 12-lead option can be identified by viewing the ECG/Resp Revision screen. To do this:

1. Select **Main Setup**
2. Select **Revision**
3. Select **ECG/Resp**

4. An onscreen window indicates the Hardware and Software Revisions of the ECG/Resp. The ECG capability is displayed as either 5,6 or 12-lead.

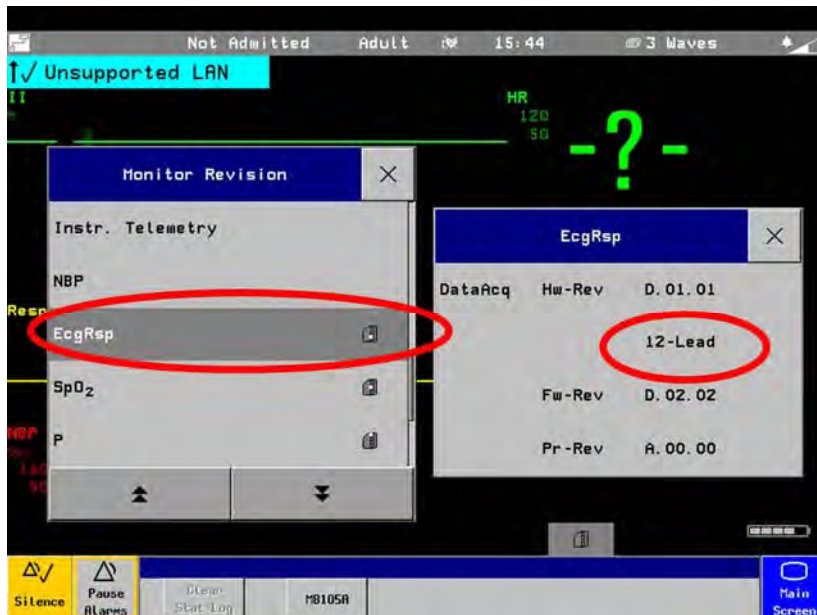

Additionally, the MP5 may be marked with the 12XL label as shown below.



## External Display Part Numbers (not for MP5T)



**M8031B External XGA Display**

### External XGA Display Parts

| Product Number | Part Number | 12NC Part No. | Description                                   |
|----------------|-------------|---------------|---|
| M8031B         | M8031-60001 | 451261001911  | 15" Medical Grade Display with Touch          |
|                | M8031-68001 | 451261001941  | Exchange 15" Medical Grade Display with Touch |
|                | M8031-60005 | 451261001921  | Power Supply 12V for M8031B Display           |
|                | M8031-64001 | 451261001931  | Power Supply Mounting for M8031B Display      |
|                | M8031-04701 | 451261001901  | Monitor Desk Stand for M8031B/M8033C          |
|                | 2090-0860   | 453563463201  | Backlights for M8031B                         |



**M8033C External SXGA Display**

### External SXGA Display Parts

| Product Number | Part Number | 12NC Part No. | Description  |
|----------------|-------------|---------------|--|
| M8033C         | M8033-60071 | 451261009151  | M8033C New 17" Medical Grade Monitor with Touch      |
|                | M8033-68071 | 451261009161  | M8033C Exchange 17" Medical Grade Monitor with Touch |
|                | M8031-04701 | 451261001901  | Monitor Desk Stand for M8031B/M8033C                 |
|                | M8033-64603 | 451920880311  | Backlights for M8033C                                |

---

# Installation Instructions

Installation should be carried out by qualified service personnel, either by the hospital's biomedical department, or by Philips Support.

The monitor is suitable for use in all medically used rooms which fulfil the requirements regarding electrical installation according to IEC60364-7-710 "Requirements for special installations or locations - Medical locations, or corresponding local regulations.

The following measurements and system interfaces are, in addition, suitable for use in establishments directly connected to the public low-voltage supply network that supplies buildings used for domestic purposes (see table in Electromagnetic Emissions below):

- ECG/Respiration, NBP, SpO<sub>2</sub>, Pressure, Temperature, CO<sub>2</sub> (only Mainstream Sensor M2501A)
- LAN, Video Out, Battery, Nurse Call, RS232, and recorder interfaces

If you have purchased a "customer-installable bundle", it is assumed that your own hospital personnel (biomedical engineer or technician) will install and, if necessary, configure the monitor. You can contact Philips Support for assistance if required; any assistance will be associated with additional costs.

For mechanical and electrical installation, you need technically qualified personnel with a knowledge of English. Additionally, for monitor configuration, you need clinically qualified personnel with a knowledge of the use environment.

Installation in ambulances, airborne systems or helicopters must be performed by Philips service personnel. The monitor may not be installed in airborne systems or helicopters in the EU.

**As the first step in preparing the monitor for use, follow the installation instructions given in this chapter.**

# Out-Of-Hospital Transport - Standards Compliance

The MP5 patient monitor with measurements and interfaces other than those listed below, and the MP5T, cannot be used for patient transport outside of the hospital environment.

The MP5 patient monitor with the following measurements and interfaces:

- ECG/Respiration, NBP, SpO<sub>2</sub>, Pressure, Temperature, CO<sub>2</sub> (only Mainstream Sensor M2501A and Microstream CO<sub>2</sub>)
- LAN, Video Out, Battery, Nurse Call, RS232, and recorder interfaces

can be used in a transport environment such as a road ambulance, airplane or helicopter. For this purpose the monitor fulfils the following additional mechanical, EMC and environmental requirements:

- **Shock Tests** according to IEC TR 60721-4-7, Class 7M3. Test procedure according to IEC/EN 60068-2-27 (peak acceleration up to 100g).
- **Random Vibration** according to IEC TR 60721-4-7, Class 7M3. Test procedure according to IEC/EN 60068-2-64 (RMS acceleration 5g).
- **Sinusoidal Vibration** according to IEC TR 60721-4-7, Class 7M3. Test procedure according to IEC/EN 60068-2-6 (acceleration up to amplitude 2g).
- **Bump Test** according to IEC/EN60068-2-29 (peak acceleration 15g, 1000 bumps).
- **Free Fall Test** according to EN1789 (covers also IEC TR 60721-4-7 and Class 7M3). Test procedure according to EN 60068-2-32 (height 0.75 m).
- Specification for degrees of protection provided by enclosures according to **IEC/EN 60529: IP 32**
- **EN 1789 +A1:2003** Medical vehicles and their equipment - Road ambulances (chapter 6 - Medical Devices).
- **Radiated susceptibility 20 V/m** according to EN ISO 9919 (SpO<sub>2</sub>) and EN ISO 21647 (CO<sub>2</sub>).
- **Altitude Range** from -500 to 3000 m operating and -500 to 4600 m storage and transportation.
- **Extended radiated susceptibility tests**
  - GSM-900: Immunity at 900 MHz (uplink mobile phone), 20 V/m, Pulse/Pause Ratio 1:7
  - GSM-1800: Immunity at 1800 MHz (uplink mobile phone), 20 V/m, Pulse/Pause Ratio 1:7
  - DECT: Immunity at 1800 MHz (digital cordless phone), 20 V/m, Pulse/Pause Ratio 1:23
  - AM: 1kHz Immunity from 80 MHz to 1.0 GHz (any radio communication unit; Broadcasting and TV transmitters), 20 V/m, modulation factor 80%



**CAUTION**

Temperature measurement accuracy may be compromised in the presence of strong electromagnetic fields (>3 V/m) in certain small frequency bands.

- **Magnetic Field emission** according to MIL STD 461E, Chapter RE101: Radiated emissions, magnetic field, 30 Hz to 100 kHz
- **Magnetic Field susceptibility:** Radiated susceptibility, magnetic field, 50, 60 and 400 Hz, 18  $\mu$ T(15 A/m)
- **Operating ambient temperature** testing over the range from 0 to 40 °C (32 to 100 °F).
- **Operating ambient humidity** testing up to 95% RH at 40 °C (100 °F), non condensing.

**NOTE**

There may be additional requirements for transport situations in air, on water or in difficult terrain in certain countries, e.g. EU.

## Electromagnetic Emissions

The monitor is suitable for use in the electromagnetic environment specified in the table below. You must ensure that it is used in such an environment

| Emissions test                     | Compliance | Avoiding Electromagnetic Interference  |
|------------------------------------|------------|--|
| Radio Frequency (RF) emissions     | Group 1    | The monitor uses RF energy only for its internal function. Therefore, its RF emissions are very low and are not likely to cause any interference in nearby electronic equipment  |
| RF emissions CISPR 11              | Class A    | The monitor is suitable for use in all establishments other than those directly connected to the public low-voltage power supply network that supplies buildings used for domestic purposes.   |
| RF emissions CISPR 11              | Class B    | The monitor, with the following measurements and interfaces:<br>ECG/Respiration, NBP, SpO2, Pressure, Temperature, CO2 (only Mainstream Sensor M2501A)<br>LAN, Video Out, Battery, Nurse Call, RS232, and recorder interfaces<br>is suitable for use in all establishments including those directly connected to the public low-voltage power supply network that supplies buildings used for domestic purposes. |
| Harmonic emissions IEC 61000-3-2   | complies   |  |
| Voltage fluctuations IEC 61000-3-3 | complies   |  |

## Electromagnetic Interference (SRR)

Commercially available Short Range Radio 802.15.4 transceivers operate at very low RF power levels to transmit data and need to have high sensitivity receivers to achieve a good link budget. Due to technological limitations the selectivity of the receiver is limited. Consequently, the SRR link is susceptible to other strong RF transmitters not only in the operating frequency band and 5% around it, but also to non-transient RF disturbances stronger than 1V/m at frequencies close to the operating frequency band (2.0 to 2.3 GHz)

## Installation Checklist

Use this checklist to document your installation.

| Step | Task  | Check Box when Task Done |
|------|---|--------------------------|
| 1    | Perform initial inspection of delivery, unpack and check the shipment<br>(see " <i>Unpacking and Checking the Shipment</i> (on page 219)")  |                          |
| 2    | Mount the monitor as appropriate for your installation<br>(see <i>Mounting the Monitor</i> (on page 221))   |                          |
| 3    | Connect the monitor to AC mains using the supplied power cord (see The quick mount domes are attached to the rollstand with three M6x10 FHMS screws as shown below. For details see IfU provided with the rollstand.) |                          |
| 4    | Perform Visual, Power On and Functional test blocks (see <i>Checking Out The Monitor</i> (on page 227))   |                          |
| 5    | Perform Safety Tests, if required by local laws and regulations (see <i>Checking Out The Monitor</i> (on page 227))   |                          |
| 6    | Load paper into the recorder, if present (see <i>Loading Paper</i> (on page 229))   |                          |
| 7    | Check/set the time and date (see <i>Setting the Date and Time</i> (on page 233))  |                          |
| 8    | Check that the country-specific default settings are appropriate (see <i>Checking Country-Specific Default Settings</i> (on page 230))  |                          |
| 9    | Perform System Test as necessary  |                          |

# Unpacking and Checking the Shipment

The monitor and any supporting options ordered are supplied packed in protective shipping cartons.

## Initial Inspection

Before unpacking, check the packaging and ensure that there are no signs of mishandling or damage.

Open the package carefully and remove the monitor and accessories.

Check that the contents are complete and that the correct options and accessories have been delivered

| System Components, Accessories and Supplies                            | Comments |
|--|----------|
| Monitor with options as ordered  | 1        |
| ECG accessories  | optional |
| NBP accessories  | 1        |
| SpO <sub>2</sub> accessories   | optional |
| Pressure accessories (not for MP5T)                                    | optional |
| Temperature accessories (not for MP5T)                                 | optional |
| Predictive Temperature accessories                                     | optional |
| CO <sub>2</sub> Accessories (not for MP5T)                             | optional |
| Microstream CO <sub>2</sub> Accessories (not for MP5T)                 | optional |
| Recorder paper   | optional |
| Power Cord   | 1        |
| Telemetry Interface cable  | optional |
| Measurement Link (MSL) cable (not for MP5T)                            | optional |
| Instructions for Use   | 1        |
| Quick Guide  | 1        |
| Documentation CD-ROM (includes Service Guide and Instructions for Use) | 1        |

## Electrical Inspection

The instrument has undergone extensive testing prior to shipment. All tests are described in the *Testing and Maintenance* section of this manual. Additional tests may be required according to local requirements.

## Claims For Damage and Repackaging

### Claims for Damage

When the equipment is received, if physical damage is evident or if the monitor does not meet the specified operational requirements of the patient safety checks or the extended self check, notify the carrier and the nearest Philips Sales/Support Office at once. Philips will arrange for immediate repair or replacement of the instrument without waiting for the claim settlement by the carrier.

### Repackaging for Shipment or Storage

If the instrument is to be shipped to a Philips Sales/Support Office, securely attach a label showing the name and address of the owner, the instrument model and serial numbers, and the repair required (or symptoms of the fault). If available and reusable, the original Philips packaging should be used to provide adequate protection during transit. If the original Philips packaging is not available or reusable please contact the Philips Sales/Support Office who will provide information about adequate packaging materials and methods.

## Installing the Predictive Temperature Probe

1. Attach the probe connector to predictive temperature assembly.



2. Insert the probe cable into the slot provided at the bottom of the predictive temperature assembly.

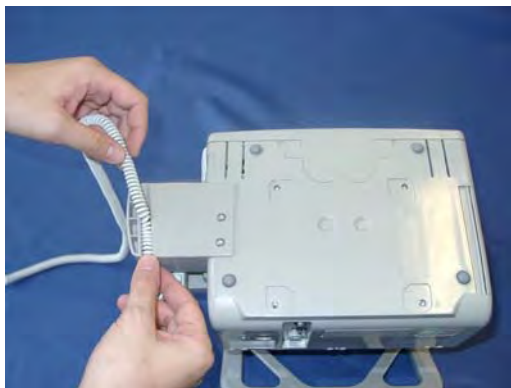

3. Insert the probe holder as shown below.



4. Insert the probe into its holder.



## Mounting the Monitor

Every type of compatible mounting solution is delivered with a complete set of mounting hardware and instructions. Refer to the documentation delivered with the mounting hardware for instructions on assembling mounts.

---

### WARNING

- It is the customer's responsibility to have the attachment of the mounting hardware to the ceiling, wall, or mounting rail and the construction of the ceiling, wall, or mounting rail evaluated for structural integrity and compliance with all local, state and any other required codes by a registered, professional, structural and/or mechanical engineer.

Ensure that this commitment has been met before assembling mounts.

- Incorrect mounting and use of inappropriate mounting material may lead to injury. It is the customer's responsibility to ensure that the mounting procedures have been performed correctly and the appropriate mounting devices have been used.
-

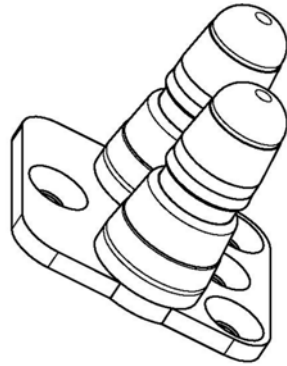

....

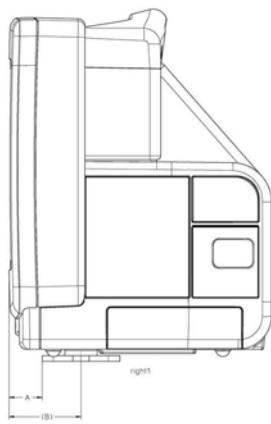
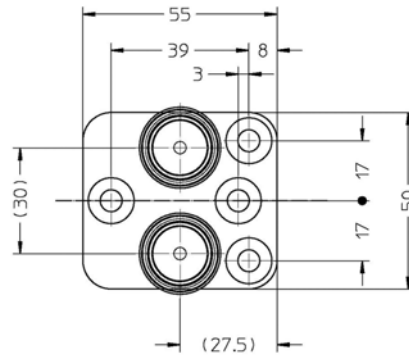

**Table Mount (M4046-64100, 12NC: 451261001381) - MP5 shown as an example**

|         | A    | (B)  |
|---------|------|------|
| MP5     | 24   | 51.5 |
| MP20/30 | 85.5 | 113  |
| MP40/50 | 79.5 | 107  |
| MP60/70 | 62   | 89.5 |

## Mounting the Monitor using the Quick Mount

Mounting the monitor using the quick mount requires an installed and functioning quick mount solution inside the monitor. This quick mount solution is optional and can also be purchased as an upgrade option. For details on installing the quick mount solution inside the monitor, refer to the Repair and Disassembly section.



The monitor with the internal quick mount solution is mounted onto the quick mount domes as shown below:

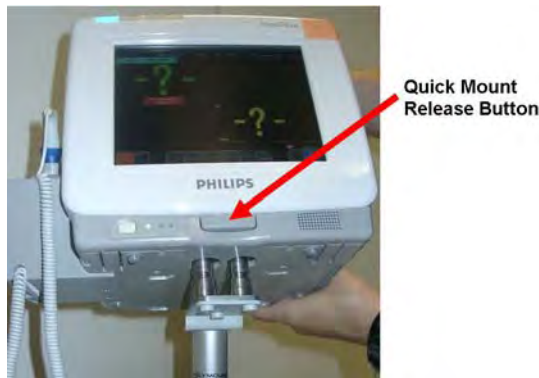

### NOTE

Make sure that the quick mount domes are properly and completely inserted into the quick mount solution of the monitor. This is signalled by a click.

---

### WARNING

When you press the quick mount release button, the release mechanism remains open for a delay time of a few seconds. During this time the monitor is easily removable from the tabletop mount domes and may fall down if lifted upwards.

---

### Mounting the Monitor onto the Rollstand using the Quick Mount

The quick mount domes are attached to the rollstand with three M6x10 FHMS screws as shown below. For details see IfU provided with the rollstand.



### Mounting the Monitor on the Wall Mount using the Quick Mount

The quick mount domes are attached to the wall mount with one M6x12 FHMS and two M6x8 FHMS screws. For details see IfU provided with the wall mount.

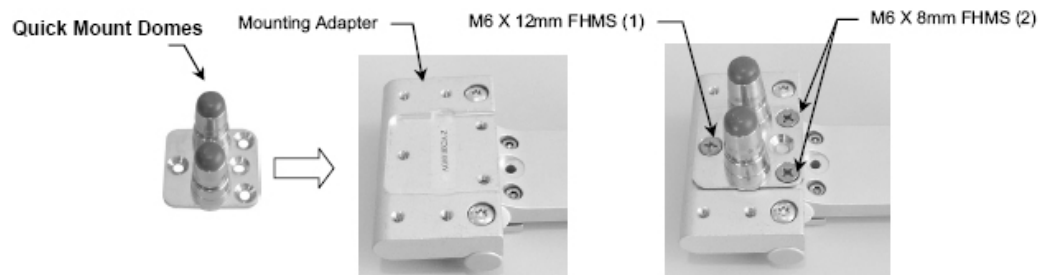

### Mounting the Monitor using the Mounting Plate (Fix Mount)

1. The mounting plate is attached to the monitor with four screws





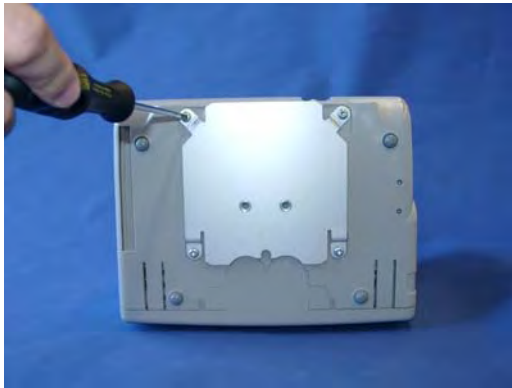

2. Mount the mounting plate on a level surface with two screws.

**NOTE**

The mounting plate is not designed for out-of-hospital use (e.g. ambulance, helicopter, airplane)

**Mounting the Monitor onto the Rollerstand using the Mounting Plate**

1. The monitor can be attached to the rollerstand as shown below. For details see the IfU provided with the rollerstand.



### Mounting the Monitor on the Wall Mount using the Mounting Plate

The mounting plate is attached to the wall mount with two M6x14 PHMS screws. For details see IfU provided with the wall mount.

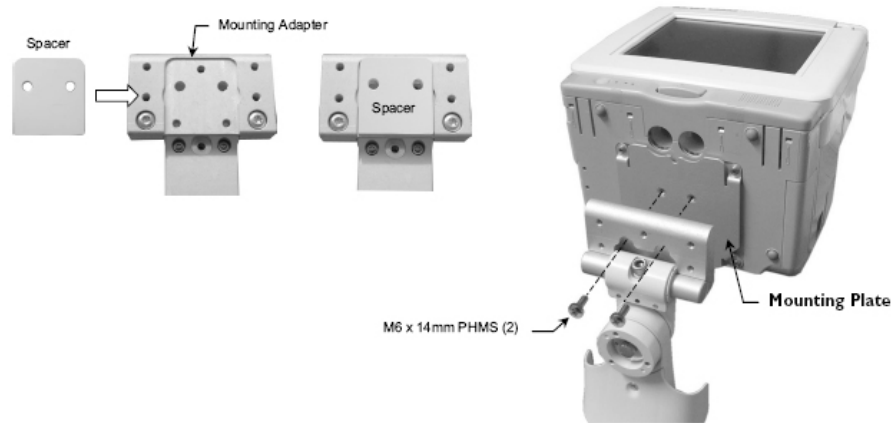

#### NOTE

The mounting plate is not designed for out-of-hospital use (e.g. ambulance, helicopter, airplane).

## Connecting the Monitor to AC Mains

The monitor has a wide-range power supply that allows you to operate the monitor from an AC (alternating current) power source of 100 V to 240 V ( $\pm 10\%$ ) and 50/60 Hz ( $\pm 5\%$ ).

#### WARNING

- Always use the supplied power cord with the earthed mains plug to connect the monitor to an earthed AC mains socket. Never adapt the mains plug from the power supply to fit an unearthed AC mains socket.
- Do not use AC mains extension cords or multiple portable socket-outlets. If a multiple portable socket-outlet without an approved isolation transformer is used, the interruption of its protective earthing may result in enclosure leakage currents equal to the sum of the individual earth leakage currents, so exceeding allowable limits.
- Do not connect any devices that are not supported as part of a system.
- Any non-medical device placed and operated in the patient's vicinity must be powered via an approved isolation transformer that ensures mechanical fixing of the power cords and covering of any unused power outlets.

## Checking Out The Monitor

The following table defines which tests and inspections need to be performed, and when they are required.

| Test         | Test or Inspection to be Performed  |
|--------------|---|
| Visual       | Inspect the monitor, measurement accessories and cables for any damage.<br><br>Are they free of damage?   |
| Power On     | Power on the monitor. Does it start up successfully without errors? Do all alarm lamps light up during power up?<br>After start up the monitor sounds a tone, and you can see the monitoring main screen (normally with measurement wave channels and numeric positions).   |
| Safety Tests | Perform safety tests, as described in the <i>Testing and Maintenance section</i> , for standalone devices if required by local laws and regulations, and each time you combine equipment to form a system, or exchange system components. Details of the safety tests and procedures are described in the <i>Testing and Maintenance section</i> . These safety tests are derived from international standards but may not always be sufficient to meet local requirements. |
| System       | Perform the system test according to IEC 60601-1-1, if applicable, after combining equipment to form a system.  |

For test and inspection information regarding repairs, upgrades and all other service events, refer to the *Testing and Maintenance section*.

### Connections

The following figure shows the cable and interface board connections.



**MP5 Cable and Interface Board Connections**

**NOTE**

The Nurse Call and RS232 connections are only available on the full system interface board. The basic system interface board only contains the LAN and the video connector. The battery system interface board only contains the LAN connector.

**Connection of Devices via the MIB/RS232 Interface**

The configuration of the MIB/RS232 port can be viewed in config mode and altered in service mode. This is required, for example, when a slave display with touchscreen is installed. To alter the configuration of an MIB port select **Main Setup** then **Hardware** then **Interfaces**. You can configure **Data Out**, **GM**, and **Touch** to the MIB/RS232 port.

For details on the ECG Sync Pulse refer to the *ECG Sync Pulse (not for MP5T)* (on page 243) section of this chapter.

**NOTE**

Be aware that if you change a port assignment this assignment is not reset upon boot up. If the system interface board is removed and replaced with a different type of board the settings are deleted. If the original board is then refitted, you must reconfigure the MIB/RS232 port. The configuration of MIB/RS232 is not cloned between services.

**NOTE**

Removing the system interface board erases the status log of the monitor. Please make sure to save the status log using the support tool before removing the system interface board. Refer to the support tool instructions for use for further details.

The MIB/RS232 port is in BCC mode.

| Computer Client | Pin and Signal Direction | MP5 monitor |
|-----------------|--------------------------|-------------|
| GND             | 4 <=>                    | GND         |
| TxD             | 5 =>                     | RxD         |
| RxD             | 7 <=                     | TxD         |
|                 | 8 <=                     | PWR         |

The pins from the RJ45 are counted from 1 for the lowest pin to 8 for the highest pin when looking at the RS232/MIB interface board.

An adapter from D-SUB (PC interface) to MIB (monitor interface) may be made with the following pin assignment:

| Computer Client | D-SUB 9 pin | D-SUB 25 pin | dir. | MIB pin | MP5 monitor |
|-----------------|-------------|--------------|------|---------|-------------|
| GND             | 5           | 7            | <=>  | 4       | GND         |
| TxD             | 3           | 2            | =>   | 5       | RxD         |
| RxD             | 2           | 3            | <=   | 7       | TxD         |
|                 |             |              | NC   | 8       | PWR         |

For more details on data output to computer systems, refer to the Data Export Programming Guide.

## Loading Paper

1. Use the latch on the right side of the recorder door to pull the door open.
2. Remove the empty core.
3. Insert a new roll and secure it in place on the paper holder. The paper feeds from the bottom of the roll and over the top of the recorder door. Recommended paper: M4816A and M4817A.



4. With at least one inch of paper extending beyond the edge of the door, swing the recorder door up and push it firmly closed.
5. To test if paper is loaded correctly, start a recording. If no printing appears, paper may be loaded backwards or the wrong paper may be inserted. Try reloading the paper. Make sure you are using the correct paper.

## Configuration Tasks

You must configure these settings during installation in configuration mode.

- Line Frequency
- Altitude
- Equipment Label (for wireless networked monitors, or when the Information center is in flexible monitoring mode).
- IP Address, Subnet Mask and Default Gateway (for manual IP Address Configuration - only in **service mode**)
- ECG cable colors
- Height and Weight units
- IGMP, CI Mode, CI Address, CI TTL (for Customer Supplied Clinical Network (CSCN) Routed Bedside Configurations) - only in **service mode**)

## Checking Country-Specific Default Settings

Some settings are made in the factory to match the typical requirements in a specific country. Line frequency, units for weight and height, and ECG cable colors (AAMI or IEC) have been set to appropriate values. If you suspect that these settings may not match your institution's requirements, check the settings and change them if necessary as described in the *Configuration Guide*. Default settings are listed in Appendix B.

---

### WARNING

Before starting monitoring, check that the configuration meets your requirements, especially patient category, alarm limits and paced setting.

---

If you need to enter configuration mode:

1. In the **Main Setup** menu, select **Operating Modes**.
2. Select **Config** and enter the passcode.

The passcode for configuration mode is given in the monitor's service documentation.

The monitor displays **Config** at the right hand side of the status line and in the center of the Screen while you are in configuration mode.

Before you leave configuration mode, always be sure to store any changes you made. You must store changes made to each Settings Block and to each Profile, individually. As it may be difficult to remember whether the settings you changed belong to a Monitor Settings block or a Measurement Settings block, we recommend that you store each block before you leave configuration mode.

To leave configuration mode:

- ▶ In the **Main Setup** menu, select **Operating Modes** and then select **Monitoring**.

## Setting Altitude, Line Frequency, ECG Cable Colors and Height & Weight Units

You require a local barometric pressure rating from a reliable source (such as airport, regional weather station, or hospital weather station) that is located at the same altitude as the institution.

1. From the **Main Setup** menu, select **Global Setting**. Select **Altitude** and enter the altitude.
2. From the **Main Setup** menu, select **Global Setting**. Select **Line Frequency** and choose the Line Frequency.
3. From the **Main Setup** menu, select **Global Setting**. Select **ECG Cable Color** and choose the Cable Color.
4. From the **Main Setup** menu, select **Global Setting**. Select **Height Unit** and choose the Height unit.
5. From the **Main Setup** menu, select **Global Setting**. Select **Weight Unit** and choose the Weight unit.

## Configuring the Equipment Label

If the Information Center is in fixed monitoring mode, it controls the equipment label. You do not need to follow this procedure.

However, if you are on a wireless network, or your Information Center is configured for flexible monitoring mode, you must set the equipment label. This associates the monitor with a central monitoring sector. An identical monitor label must also be configured in the Information Center.

1. Select the **Bed Label** screen element to call up the **Bed Info** menu.
2. Select **Equipment Label** to call up the onscreen keyboard.
3. Enter the system identifier. This needs to be set up in either the monitor or the information Center. If the Information Center is in flexible monitoring mode, the monitor must be setup to match the Information Center's monitor label.

## Configuring IP Address, Subnet Mask and Default Gateway

Typically the automatic configuration via the BOOTP Server of the central station is used. In this case all fields are set to 0.0.0.0. For special requirements, it is possible to switch to a manual/fix IP address configuration.

### NOTE

- Only limited checks of the manual values are possible. Therefore, it is mandatory that a manual configuration is only performed by an experienced service person to avoid problems such as duplicate IP addresses, non matching subnet mask, etc.
  - The second CPU of an MP90 does not support a manual configuration and therefore will always request the IP configuration via BOOTP.
1. Select the **Bed Label** screen element to call up the **Bed Info** menu.
  2. Select **IP Address**. If the IP Address is set to 0.0.0.0, all values are dynamically requested from a BOOTP Server. Otherwise the manually entered address is used.
  3. Select **Subnet Mask**. The Subnet Mask must be provided for manual IP addresses. The Subnet Mask must consist of a single consecutive series of "1" bits; e.g. 255.255.248.0. The configured value is ignored when the IP Address is provided by a BOOTP Server.
  4. Select **Default Gateway**. The IP Address of the Default Gateway can be optionally configured. The configured value is ignored if IP Address and gateway are provided by a BOOTP Server. The configured value must be within the range of the Subnet Mask.

## Configuration Settings for CSCN Routed Bedside Monitors (RBM)

The following settings are used for Customer Supplied Clinical Network (CSCN) Routed Bedside monitors. To access these settings, select the **Bed Label** screen element to call up the **Bed Info** menu.

**IGMP:** Shows status of IGMP Support (On or Off). IGMP (Internet Group Multicast Protocol) is used by many switch manufacturers to limit the number of destinations targeted by a multicast packet.

**CI Mode:** The mode in which CI messages (Connect Indication messages) are sent (Broadcast, Multicast, Manual).

**CI Address:** IP Address for Connect Indication messages only being used if CI Mode is set to Manual. If CI Mode is Broadcast the CI Address is implicitly the subnet broadcast address. If CI Mode is Multicast the CI Address is implicitly 224.0.23.63.

**CI TTL:** Sets the TTL (Time To Live) of the CI message. Defaults to 1.

## Configuring Routed Bedside Monitors Support

An IntelliVue MP2/X2, MP5/MP5T or MP20-90 monitor must be running software revision level G.0 or higher to be used as a routed bedside monitor (RBM).

---

### CAUTION

A Philips Routed Bedside Monitor may temporarily stop displaying its Care Group overview bar for up to 60 seconds if a network link carrying multicast traffic between the Philips IntelliVue Information Center and the network routers is lost. While the multicast traffic is being re-routed, the monitor will not display the Care Group overview bar but will maintain connectivity to its associated Philips IntelliVue Information Center. Primary monitoring/alarms will remain available at the Routed Bedside Monitor and its associated Philips IntelliVue Information Center while the multicast traffic is being re-routed.

---

To configure an IntelliVue Patient Monitor to function as an RBM:

1. Put the monitor into Service Mode
2. Select Main Setup => Bed Information => IGMP and set IGMP to On.
3. Select Main Setup => Bed Information => CI Mode and set CI Mode to Multicast.
4. Select Main Setup => Bed Information => CI TTL, and set CI TTL to a value of 8.
5. Store the settings.
6. The CI Address will change to 224.0.23.63.
7. Return the monitor to its normal operational mode.

For further information regarding CSCN Routed Bedside Monitors refer to the CSCN Specifications (P/N: 4535 640 24951)



## Setting the Date and Time

To set the date and time:

1. Select the **Date, Time** screen element from the monitor's info line to enter the **Date, Time** menu.
2. Select, in turn, the **Year, Month, Day, Hour** (in 24 hour format, only) and **Minute** as necessary. Select the correct values from the pop-up list.
3. Select **Store Date, Time** to change the date and time.

If your monitor is connected to an Information Center, the date and time are automatically taken from this.

Once it is set, the internal clock retains the setting even when you switch off the monitor.

## Handing Over the Monitor

If you are handing over the monitor to the end-users directly after configuration, make sure that it is in Monitoring mode.

Ensure that the users have access to the following documentation delivered with the monitor:

- Training Program - M8105-9441x - for self-training on the monitor before use
- Quick Guide - M8000-9101x - for quick reminders during use
- Instructions for Use - M8105-9001x - for more detailed questions during use

---

### WARNING

All users must complete the training program (M8105-9441x) and read the Instructions for Use before working with the monitor.

---

These training materials (in combination with this service guide) can also be used to train service personnel on how to use and service the MP5 monitor.

## Installing Remote Devices (not for MP5T)

This section provides instructions for Philips products. Installation instructions for devices not sold by Philips must be provided by the device manufacturer.

### Mounting the 15" Remote Display (M8031B)

Mounting solutions for the M8031B must be purchased separately. Please refer to the installation instructions which ship with the mounting solution purchased.

**Connections**

Connect the cables to the display as shown in the photographs below.



| No. | Description                                |
|-----|--|
| 1   | Power Connector                            |
| 2   | Digital Video Connector (not used for MP5) |
| 3   | Analog Video Connector                     |

**Mounting the 17" Remote Display (M8033C)**

Mounting solutions for the M8033C must be purchased separately. Please refer to the installation instructions which ship with the mounting solution purchased.

**Connections**

Connect the cables to the display as shown in the photographs below.



**Connections M8033C**

## Video Cable Wiring Schematics

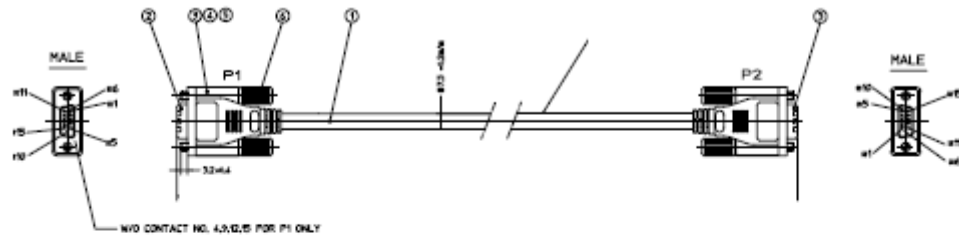

| CIRCUIT DIAGRAM |                     |       |
|-----------------|---------------------|-------|
| P1              | WIRE                | P2    |
| 1               | RED COAX. CENTER    | 1     |
| 2               | GREY COAX. CENTER   | 2     |
| 3               | BLUE COAX. CENTER   | 3     |
| 5               | BLACK               | 5     |
| 10              |                     | 10    |
| 6               | RED COAX. SHIELD    | 6     |
| 7               | GREY COAX. SHIELD   | 7     |
| 8               | BLUE COAX. SHIELD   | 8     |
| 11              | BROWN               | 11    |
| 13              | YELLOW              | 13    |
| 14              | WHITE               | 14    |
|                 | SHELL — OVER SHIELD | SHELL |

### Analog Video Cable Wiring Schematic

## Hardware Settings

This section lists all the settings grouped in the Hardware Settings Block which are available in Service Mode. These settings are set once per monitor and are the same in every profile. Any changes you make to the hardware settings configuration are automatically stored, there is no need to save them in an extra step. Hardware settings must be entered for each monitor individually, they are stored in the monitor, and they are not cloned. To enter the hardware settings menu, select **Main Setup** -> **Hardware**.

- Setup Video - this setting allows you to set the correct display resolution for the displays.
- MIB/RS232 - see *Connection of Devices via the MIB/RS232 Interface* (on page 228) section in this chapter for details.

## Philips Clinical Network (Wired) (not for MP5T)

Installation of the Philips Clinical Network should be performed by Philips service personnel. Use unshielded twisted pair (UTP) cables for installation of the clinical network. Refer to the installation instructions in the M3185A Installation Manual for further details.

## Philips Clinical Network (Wireless) (not for MP5T)

Refer to the installation instructions in the M3185A Philips Clinical Network Installation Manual for network installation instructions when using the wireless ethernet adapter.

Refer to the IntelliVue 802.11 a/g Infrastructure Installation and Configuration Guide for network installation instructions when using the IntelliVue 802.11 Bedside Adapter. For instructions on connecting the IntelliVue 802.11 Bedside Adapter, please refer to the Hardware Upgrade Guide for your bedside monitor.

## Philips IntelliVue Information Center

Please refer to the installation instructions and Instructions for Use of the -USR\_ProductName- Information Center Rev. System J or higher.

# IntelliVue Instrument Telemetry (IIT) (not for MP5T)

Frequency Coordination (USA only):

Frequency coordination is a registration and coordination process for wireless medical telemetry devices used in the U.S.A. which operate in the FCC-allocated Wireless Medical Telemetry Service (WMTS) bands (608-614 MHz, 1395-1400 MHz, 1427-1432 MHz). The M8001/2A #J45 and the M8004/5A with the -USR\_ProductName- Instrument Telemetry adapter M2638A operate in both of the 1395-1400 and 1427-1432 MHz bands.

Under U.S. Federal Communications Commission (FCC) rules, authorized healthcare providers must register their WMTS devices with an authorized Frequency Coordinator designated by the FCC. The American Society for Healthcare Engineering (ASHE) is the current designated Frequency Coordinator.

Registration/Coordination is a two-step process.

**Step 1: Registration:** Register the healthcare facility on-line, from the ASHE website ([www.ashe.org](http://www.ashe.org) (<http://www.ashe.org/n>)). Click on the link for Wireless Medical Telemetry Service and come to the registration page. Fill out the details, and pay the associated fee as per the instructions provided. You will receive confirmation of this registration. Confirmation must be received before proceeding to the next step.

**Step 2: Frequency Coordination:** Along with confirmation of registration, you will receive access information necessary to perform this second step, frequency coordination. This step involves logging the equipment and frequencies used into the FCC's database, so as to identify any existing potential interference and to help prevent potential future interference. Coordination is accomplished via the ASHE website. Click on the links for Wireless Medical Telemetry Service and then Frequency Coordination. The way the coordination process is executed as of today, it will need to be repeated twice for the M4840A system; once for the 1395-1400 MHz band, and then again for the 1427-1432 MHz band, both of which are used concurrently by the Philips product. There is a separate fee for each coordination request, which varies between \$250 and \$2000, depending upon the number of transmitting devices used and the band/s of operation. Coordination is executed by a company named Comsearch, on behalf of ASHE.

To fill in the frequency coordination forms, you'll need to know the following:

- The county.
- Latitude and longitude that represents the center of the area where the transmitting devices will be deployed. Comsearch can help provide this information; [www.comsearch.com](http://www.comsearch.com) provides contact information.
- The name/s of the Clinical Unit/s using the devices (e.g. ICU4, CCU-West, ER1, Step-Down North, etc).
- The radius of deployment, expressed in meters. Imagine drawing a circle around the center of the clinical unit, that encloses/encompasses the unit. What is its radius?
- The number of the highest floor on which a transmitting device will operate.

- How many transmitting devices will be used, i.e. the total number of IntelliVue Instrument Telemetry adapter devices combined.
- The Effective Radiating Power: 6.3 mW.
- The Equipment Manufacturer: Philips Medical Systems.
- The Model numbers: M8105A #J45 IntelliVue Instrument Telemetry adapter used with M8105A (MP5)
- The Frequency Range to be used: Two separate coordinations are required: For the first one, click on the range of 1395.0 through 1400.0 MHz. For the second one, click on all the frequency ranges listed in the range of 1427.0 through 1432.0 MHz.

When both Registration and Frequency Coordination have been successfully completed, the IntelliVue Instrument Telemetry System can be activated. Note that this process is the responsibility of the customer, as the final “operator” of the transmitting equipment.

## Short Range Radio

Installation of the Short Range Radio interface should be performed by Philips service personnel. Before installing an SRR infrastructure it might be necessary to perform a site survey to determine available channels. This should be performed by Philips telemetry installation experts.

### Configuring SRR Channels

Hardware Setting: **Main Setup -> Hardware -> SRR Channel**

SRR channel settings only apply for monitors that have a short range radio interface installed. They must be set to match the hospital’s wireless infrastructure. SRR channel settings are hardware settings and will typically be set by service personnel at installation.

Refer to your configuration guide for details.

## SRR Channel Settings Configuration Implications

**Channel** Use this setting to configure the SRR channel the monitor should use. SRR provides a total of 16 channels in the ISM (2.4 GHz) band. The channels are labeled 11 to 26. Up to two SRR connections can be established per channel. The ISM band is not exclusively reserved for SRR applications. It is also used by, for example, Wireless LAN (WLAN) and the IntelliVue Telemetry network (except for the US). For this reason, depending on the hospital's existing wireless infrastructure, a number of SRR channels might already be occupied by other wireless applications.

To achieve the best SRR performance possible, follow these recommendations:

- Usage of WLAN together with SRR may cause interferences. Each WLAN network uses at least four of the 16 SRR channels. If the use of WLAN cannot be avoided, limit the number of channels used for the WLAN infrastructure to a minimum.
- Usage of Bluetooth devices together with SRR may cause interferences. Bluetooth devices automatically change channels regardless of whether a channel is already used by another component of the wireless infrastructure and therefore interfere with SRR connections.
- Usage of cordless phones using the ISM band in the vicinity of SRR devices may cause interferences.
- Usage of wireless PC keyboards or mice using the ISM band in the vicinity of SRR devices may cause interferences.

### **To assign SRR channels to all monitors in a unit that should be used with SRR connections,**

1. Identify unused SRR channels. This can be done by using commercially available tools, such as AirMagnet.
2. Obtain a floor plan of the unit and identify where the monitors with SRR interface are located.
3. Determine SRR groups. An SRR group may contain a maximum of two monitors which share the same SRR channel. Monitors belonging to an SRR group should be located close to each other.
4. For each SRR group, assign the same SRR channel to all monitors belonging to a group.

**SRR Channel Restrictions with WLAN, IIT, and DECT Devices**

The following table and graphic show the restrictions of WLAN, IIT, or DECT Device usage together with SRR.

|  |                   |                   |                   |    |    |         |    |    |    |    |    |         |    |    |    |                   |  |
|--|-------------------|-------------------|-------------------|----|----|---------|----|----|----|----|----|---------|----|----|----|-------------------|--|
| US WLAN<br>(802.11)                        | 1                 |                   |                   |    | 6  |         |    |    |    |    | 11 |         |    |    |    |                   |  |
| Europe<br>WLAN<br>(802.11)                 | 1                 |                   |                   |    | 7  |         |    |    |    |    | 13 |         |    |    |    |                   |  |
| IIT 2.4 GHz<br>(Smart Hopping<br>Channels) | 0 - 13            |                   |                   |    | 14 | 15 - 30 |    |    |    |    |    | 29 - 47 |    |    |    |                   |  |
| SRR<br>(802.15.4)                          | 11<br>2405<br>MHz | 12<br>2410<br>MHz | 13<br>2415<br>MHz | 14 | 15 | 16      | 17 | 18 | 19 | 20 | 21 | 22      | 23 | 24 | 25 | 26<br>2480<br>MHz |  |

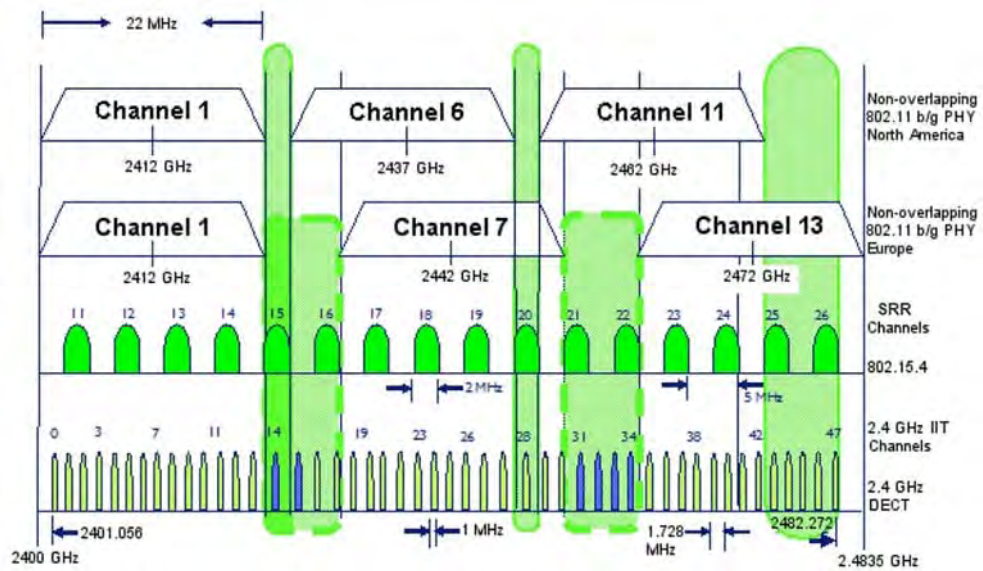



For a successful SRR deployment, the SRR channels must be located in RF spectra where they are least likely to be interfered with. Choosing appropriate channels after reviewing the Spectrum Analyzer data is critical. In hospitals, 802.11 systems are most the likely source of interference with SRR channels. The figures above show the relationship between 802.11, IIT, and DECT Devices. For example, if the site uses European 802.11 channel 1 for WLAN and has no IIT or DECT devices in the SRR channels 15 or 16, these channels can be used for SRR. Philips telemetry experts will identify available SRR channels by performing a site survey.

When using the Philips IntelliVue 802.11 Bedside Adapter we recommend that you use the 5 GHz band to free the 2.4 GHz band for SRR usage.

**NOTE**

Short range radio signals are low power signals and therefore have a relatively short range. You can use this fact if the number of unused channels is low, and you run out of channels. Provided the distance between two SRR groups is large enough, i.e. none of the short range radio signals transmitted by the one group can interfere with signals of the other group, you may attempt to assign the same SRR channel to both groups. Take into consideration that portable components (such as Telemetry transceiver, MP5/MP5T or an X2) belonging to one group may be temporarily used within the range of another group.

The range of SRR signals cannot be clearly defined as it depends on external factors such as the components and structure of walls, ceilings, etc.

## Connecting the MP5 to a Host Monitor (not for MP5T)

The MP5 is connected to the host monitor using the measurement link (MSL) cable:

**NOTE**

An MP5 in companion mode does not receive its power from the host monitor via the MSL. MP5 is always powered by AC power or battery.

## Nurse Call Relay (not for MP5T)

### Connections



#### **Nurse Call Relay Connection at Monitor**

The MP5 Nurse Call Relay is a single-closure relay with its contacts connected to a stereo phone jack.

| Nurse Call Relay       | Connectors  | Contact                         | Isolation |
|------------------------|---|---------------------------------|-----------|
| Basic Nurse Call Relay | 3.5 mm phone jack<br>active closed contact only (except modified nurse call relay: active open contact) | $\leq$ 100 mA,<br>$\leq$ 24 VDC | 1.5 kV    |

## ECG Out Functionality (ECG Sync) (not for MP5T)

### Connections



The cables 8120-1022 and M1181-61625 have both ends terminated. The photograph above shows the monitor side connection.

If using a non-terminated cable:

1. Strip 5 mm (3/16") insulation from leads and twist conductor strands tightly.

2. Solder leads to the connector as shown in the following diagram.

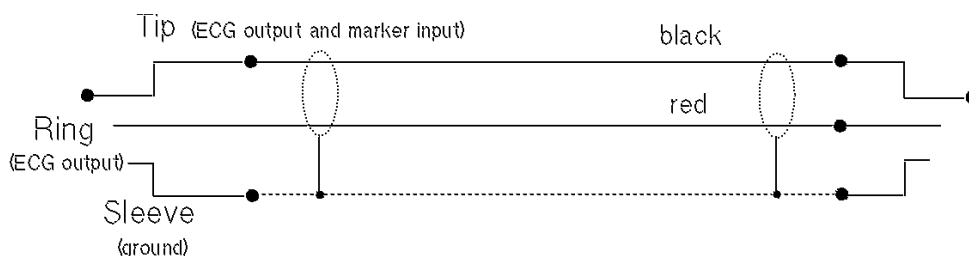

### WARNING

According to AAMI specifications the peak of the synchronized defibrillator discharge should be delivered within 60 ms of the peak of the R wave. The signal at the ECG output on the -USR\_ProductName- MP5 patient monitors is delayed by a maximum of 20 ms. Your biomedical engineer should verify that your ECG/Defibrillator combination does not exceed the recommended maximum delay of 60 ms.

### NOTE

The ECG Out is non-floating i.e. not galvanically separated.

## ECG Sync Pulse (not for MP5T)

The ECG-Sync pulse is output only if a corresponding cable is detected and the interface is configured accordingly in the monitor's settings. The detection of the cable is made by bridging two pins with a 100 Ohms resistor (preferred) or a direct connection (permitted). Note that the ECG Pulse has RS232 voltage levels and drives inputs with a resistance of 3 kOhms or higher. The ECG Pulse is active high (approximately +5V) for 100ms and low (approximately -5V) for the rest of the time, according to the RS232 levels "0" and "1", respectively.

| ECG Pulse Client  | Pin and Signal Direction | MP5 monitor        |
|---|--------------------------|--------------------|
| GND   | 4 <=>                    | GND                |
| ECG Pulse   | 7 <=                     | ECG Pulse (TxD)    |
| Cable detect:<br>bridge pins 5 and 8 with<br>100 Ohms resistor or<br>connect directly | 5 =>                     | Cable detect (RxD) |
|   | 8 <=                     | PWR                |

Make sure to configure the interface properly in Service Mode. Provide a clean ECG signal (from patient or simulator) to the monitor. Then connect the cable to the monitor and check that marker pulses are shown on the screen. At last connect the cable to the ECG Pulse Client and process the signal.

The pins of the RJ45 connector are counted from 1 for the lowest pin to 8 for the highest pin when looking at the RS232/MIB interface board.



---

# Site Preparation

## Introduction

This section describes the procedures you should follow to plan and prepare a site for an MP5 monitor installation. It describes:

- Site planning.
- Roles and responsibilities for local and Philips personnel.
- Remote installation planning.

## Site Planning

The careful planning of the site for the MP5 monitor is essential for its safe and efficient operation. *A consulting schedule should be established between the Customer and Philips Sales and Support Representatives, to ensure that all preparations are completed when the system is delivered.*

The site planning phases prior to equipment installation are:

**Location:** Planning the location of the various system components.

**Environment:** Confirming and correcting, as necessary, the environment of the proposed installation site(s).

**System Capabilities:** Explaining the possibilities for system expansion.

**Mounting:** Referencing the mounting hardware information website for the listing of suitable mounting hardware recommended for use with the various system components, and all details on the available mounts and accessories.

**Cabling:** Identifying the requirements for the cabling, conduiting and faceplates for connecting the various system components.

## Roles & Responsibilities

This section describes the procedures necessary to prepare a site for a system installation. The procedures are grouped into two parts: procedures that local staff or contractors are responsible for, and procedures that Philips personnel are responsible for.

### Site Preparation Responsibilities

#### Local Staff

- Ensure that all safety, environmental and power requirements are met.
- Provide power outlets.
- Prepare mounts.
- Pull cables, install conduit, install wallboxes.
- Terminate network cables if a Philips Clinical Network is in use.
- It may be necessary to certify the network cable plant, see Philips Clinical Network Installation Manual for details.

Alternatively, the following procedures can be performed by Philips Personnel

- Provide the customer with the safety, environmental and power requirements.
- Assemble mounts.
- Prepare monitor remote cabling.

### Procedures for Local Staff

The following tasks must be completed **before** the procedures for Philips personnel may be started.

- Providing Power Outlets

One power outlet for each display and for any peripheral device (for example, a printer or slave display) is required by the system. Provide a power outlet in the vicinity (1 m or 3 ft.) of each component that requires power.

---

### WARNING

Only the power cables provided with the system may be used. For reasons of safety, power (mains) extension cables or adapters shall not be used.

---

- Preparing Mounts

Where ceiling, wall, or shelf mounts are required for mounting the equipment, the customer is responsible for the following:

- Providing and installing all hardware which is required to install the mounting hardware supplied by Philips as detailed in the installation notes.
- Making sure that all ceilings, walls, and mounting rails that supports mounting hardware are suitable for their proposed load.

---

**WARNING**

It is the customer's responsibility to have the attachment of the mounting hardware to the ceiling, wall, or mounting rail and the construction of the ceiling, wall, or mounting rail evaluated for structural integrity and compliance with all local, state and any other required codes by a registered, professional, structural and/or mechanical engineer.

Although considerable effort has been made to ensure the safety of the ceiling mount installation and or mounting guidelines, it is to be understood that the installation itself is beyond the control of Philips Medical Systems. Accordingly, Philips Medical Systems will not be responsible for the failure of any such installation.

---

- Providing Conduit

Where a remote installation is required, for example the installation of a remote display, the customer is responsible for the following hardware installations:

- Providing conduit and/or trunking of a sufficient cross-sectional area for the planned cables and possible future expansion (for additional components or systems). See Cabling Options and Conduit Size Requirements for cable specifications for remote installations.
  - Providing and/or installing suitable wall boxes to accommodate the faceplates.
- Pulling Cables

---

**WARNING**

NEVER run power cables through the same conduit or trunking used for system cables.

---

- Installing Wall Boxes

It is the customer's responsibility to provide and install wallboxes to house faceplates. The customer must notify the Philips installation coordinator of which size is to be used.

If you have purchased a “customer-installable bundle”, it is assumed that your own hospital personnel (biomedical engineer or technician) will install and, if necessary, configure the monitor. You can contact Philips Support for assistance if required; any assistance will be associated with additional costs.

- Install the MP5 monitor using the appropriate mounting solution and perform the installation procedures as described in the Installation section.
- Hand over the monitor to the end-users as described in *Handing Over the Monitor* in the Installation section

---

**WARNING**

Incorrect installation, mounting and use of inappropriate mounting material may lead to serious injury. It is the customer's responsibility to ensure that the mounting procedures have been performed correctly, the appropriate mounting devices have been used and the monitor has been installed and configured correctly.

---

### Procedures for Philips Personnel

Before you begin the procedures in the installation sections, ensure that the customer has completed all necessary preparations outlined in the previous section, "Procedures for Local Staff."

- Install the MP5 monitor using the appropriate mounting solution and perform the installation procedures as described in the Installation section.
- Hand over the monitor to the end-users as described in *Handing Over the Monitor* in the Installation section

## Monitor Site Requirements

### Space Requirements

The siting of the monitor should be planned such that the nursing staff are able to monitor the patient with relative ease, with all patient connectors and controls readily available and the displays clearly visible. The location should also allow access to service personnel without excessive disruption and should have sufficient clearance all round to allow air circulation.

Dimensions and weight:

Size (W x H x D)

259 x 248 x 186 mm (10.2 x 9.76 x 7.32in)

Weight (with battery, without options)

< 4.4 kg (9.7 lb.)

### Environmental Requirements

The environment where the MP5 monitor will be used should be reasonably free from vibration, dust and corrosive or explosive gases. The ambient operating and storage conditions for the MP5 monitor must be observed. If these conditions are not met, the accuracy of the system will be affected and damage can occur.



## Temperature

Operating: 0 to 40°C (32 to 100°F)

Storage: -20 to 60°C (-4 to 140°F)

### **when equipped with IntelliVue 802.11 Bedside Adapter or IntelliVue Instrument Telemetry (IIT):**

Operating: 0 to 35°C (32 to 95°F)

### **when equipped with Predictive Temperature:**

Operating: 10 to 40°C (50 to 100°F)

Storage: -20 to 50°C (-4 to 120°F)

## Humidity

Operating: 15% to 95% Relative Humidity (RH) (non-condensing)

Storage and Transport: 5% to 90% Relative Humidity (RH)

## Altitude

Operating: -500m to 3000m (10000 ft.)

Storage and Transport: -500m to 4600m (15000 ft.)

## Electrical and Safety Requirements (Customer or Philips)

### Safety Requirements

If the MP5 monitor is to be used in internal examinations on the heart or brain ensure that the monitor is connected to an equipotential grounding system.

#### Grounding

The MP5 monitor **MUST** be grounded during operation (Class I equipment according to IEC 60601-1). If a three-wire receptacle is not available then the hospital electrician must be consulted to ensure that proper grounding is available on installation. **NEVER** attempt to use a three-wire to two-wire adapter with the MP5 monitor.

---

### **WARNING**

Each component must be individually grounded for safety and interference suppression purposes.

---

## Electrical Requirements

Line Voltage Connection

The MP5 monitor uses < 50W (0.7 to 0.4 A).

Line Voltage

The MP5 monitor may be operated on ac line voltage ranges of 100 to 240V (50/60 Hz).

## Remote Device Site Requirements

The system can be installed with Remote Displays

Where more than one site is used for locating equipment (a remote installation), the following sections should be considered for EACH device:

- Space Requirements
- Environmental Requirements
- Mounting
- Electrical and Safety Requirements
- Cabling Options and Conduit Size Requirements

## Connecting Non-Medical Devices

The standard IEC-60601-1-1 applies to any combination of medical and non-medical electrical devices, where at least one is a medical electrical device. Therefore IEC-60601-1-1 must still be met after all devices are connected.

For further details refer to the *Testing and Maintenance* section.

---

### WARNING

Do not use a device in the patient vicinity if it does not comply with IEC-60601-1. The whole installation, including devices outside of the patient vicinity, must comply with IEC-60601-1-1; one reasonable solution may be the use of an isolation transformer. If the monitor is used with battery operation, always use an isolation transformer when connecting an additional display.

---

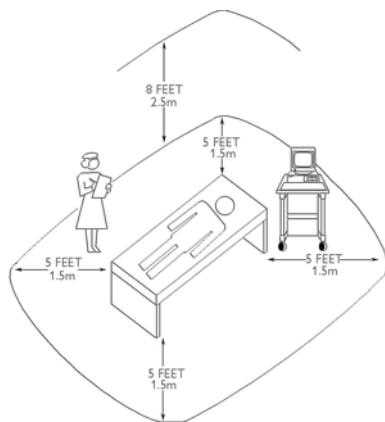

#### Equipment Location in the Patient Vicinity

### NOTE

The site planning requirements, with the exception of the cabling, must be provided by the device manufacturer, if the remote device is not purchased from Philips.

## Remote Displays - M8031B

### Space Requirements

#### Size (W x D x H)

372mm x 308mm x 74.1mm (14.65" x 12.13" x 2.92")

#### Weight

Without deskstand: 5200g (11.5lb)

With desk stand: 9000g (19.8lb)

## Environmental Requirements

### Temperature

Operating: 0 to 40°C (32 to 104°F)

Storage: -20 to 60°C (-4 to 140°F)

### Humidity

Operating: 20 to 85% RH (Non-condensing)

Storage: 5 to 85% RH (Non-condensing)

### Altitude

Operating: Up to 4000m (13123.36 ft.)

Storage: Up to 12000m (39370,08 ft.)

## Electrical and Safety Requirements

### Voltage ranges:

90V to 264V

### Voltage selection:

Wide range input, no voltage selection required

Power consumption: ~30W

## Remote Displays - M8033C

### Space Requirements

#### Size (W x Hx D)

410mm x 362mm x 103mm (16.1" x 14.25" x 4.1")

#### Weight

Without deskstand: 7 kg (15.4 lbs)

With deskstand: 10.8 kg (20 lbs)

## Environmental Requirements

### Temperature

Operating: 0 to 40°C (32 to 104°F)

Storage: -20 to 60°C (-4 to 140°F)

### Humidity

Operating: 20 to 85% RH (Non-condensing)

Storage: 5 to 85% RH (Non-condensing)

### Altitude

Operating: Up to 4000m (8000 ft.)

Storage: Up to 12000m (40000 ft.)

## Electrical and Safety Requirements

Voltage ranges:

90V to 264V

Voltage selection:

Wide range input, no voltage selection required

Power consumption: 60 watts maximum

## Cabling Options and Conduit Size Requirements

The following table describes the cabling options for the M8031A/B 15" and the M8033A/B/C 17" TFT Medical Grade Touch Displays.

### Analogue Video Cables

| Product Option Number | Part Number<br>12NC Part No. | Description                               | Conduit Sizes      | Bend Radius | Connector Size (L x W) |
|-----------------------|------------------------------|---|--------------------|-------------|------------------------|
| M8022 #VA2            | M3080-61606<br>453563484451  | 1.5m Analogue Video Cable Kit             | 64 mm <sup>2</sup> | 40 mm       | 35 x 16 mm             |
| M8022 #VA3            | M3080-61602<br>453563334661  | 3m Analogue Video Cable Kit               | 64 mm <sup>2</sup> | 40 mm       | 35 x 16 mm             |
| M8022 #VA6            | M3080-61603<br>453563334671  | 10m Analogue Video Cable Kit <sup>a</sup> | 64 mm <sup>2</sup> | 40 mm       | 35 x 16 mm             |
| M8022 #VA7            | M3080-61607<br>453563484461  | 15m Analogue Video Cable Kit <sup>a</sup> | 64 mm <sup>2</sup> | 40 mm       | 35 x 16 mm             |

| Product Option Number   | Part Number<br>12NC Part No. | Description                               | Conduit Sizes      | Bend Radius | Connector Size (L x W) |
|---|------------------------------|---|--------------------|-------------|------------------------|
| M8022 #VA9  | M3080-61608<br>453563484471  | 25m Analogue Video Cable Kit <sup>a</sup> | 64 mm <sup>2</sup> | 40 mm       | 35 x 16 mm             |
| Both ends are terminated with HDSUB15 (“VGA”) straight connectors |                              |   |                    |             |                        |
| <sup>a</sup> Built on demand                                      |                              |   |                    |             |                        |

### Touch Cable

| Product Option Number | Part Number | 12NC Part Number | Description       | Conduit Sizes     | Bend Radius | Connector Size (L x W) |
|-----------------------|-------------|------------------|-------------------|-------------------|-------------|------------------------|
| M8022A #TC2           | M8081-61010 | 451261006551     | Touch Cable, 1.5m | 30mm <sup>2</sup> | 25mm        | 35 x 16 mm             |
| M8022A #TC3           | M8081-61011 | 451261006561     | Touch Cable, 3m   | 30mm <sup>2</sup> | 25mm        | 35 x 16 mm             |
| M8022A #TC6           | M8081-61012 | 451261006571     | Touch Cable, 10m  | 30mm <sup>2</sup> | 25mm        | 35 x 16 mm             |
| M8022A #TC7           | M8081-61013 | 451261006581     | Touch Cable, 15m  | 30mm <sup>2</sup> | 25mm        | 35 x 16 mm             |
| M8022A #TC9           | M8081-61014 | 451261006591     | Touch Cable, 25m  | 30mm <sup>2</sup> | 25mm        | 35 x 16 mm             |

## Philips Medical LAN

For information refer to the IntelliVue Information Center documentation.

## RS232/MIB Interface

### *MIB Cable and Serial Cable*

| Product Option Number | Part Number<br>12NC Part No. | Description | Conduit Sizes      | Max. Bend Angle | Connector Size (L x W) |
|-----------------------|------------------------------|-------------|--------------------|-----------------|------------------------|
| M8022A #SR2           | M8081-61001<br>453563484591  | 1.5m cable  | 30 mm <sup>2</sup> | 25 mm           | 15 x 15 mm             |
| M8022A #SR3           | M8081-61002<br>453563484601  | 3m cable    | 30 mm <sup>2</sup> | 25 mm           | 15 x 15 mm             |
| M8022A #SR6           | M8081-61003<br>453563484611  | 10m cable   | 30 mm <sup>2</sup> | 25 mm           | 15 x 15 mm             |

| Product Option Number | Part Number<br>12NC Part No. | Description | Conduit Sizes      | Max. Bend Angle | Connector Size (L x W) |
|-----------------------|------------------------------|-------------|--------------------|-----------------|------------------------|
| M8022A #SR7           | M8081-61004<br>453563484621  | 15m cable   | 30 mm <sup>2</sup> | 25 mm           | 15 x 15 mm             |
| M8022A #SR9           | M8081-61005<br>453563484631  | 25m cable   | 30 mm <sup>2</sup> | 25 mm           | 15 x 15 mm             |

Both ends are terminated with 8 pin RJ45 connectors. CAT5 cable; straight through wiring.

#### Cable and Adapter Set



## Telemetry Device (Patient Worn Device) cables

#### PWD cables

| Product Option Number | Part Number<br>12NC Part No. | Description                             |
|-----------------------|------------------------------|---|
| n/a                   | 989803143481                 | 0.5m PWD interface cable (PWD side)     |
| n/a                   | 989803146911                 | 2.0m PWD interface cable (monitor side) |

## Nurse Call Relay Interface

### *Nurse Paging Cable*

| Product Option Number | Part Number<br>12NC Part No. | Description  | Conduit Sizes      | Bend Radius | Connector Size    |
|-----------------------|------------------------------|--|--------------------|-------------|-------------------|
| M8022A #NC3           | M1181-61648<br>453563375601  | 3m traditional nurse paging relay cable.<br><br>One end terminated with phone plug, one end without connector. | 13 mm <sup>2</sup> | 20 mm       | Diameter<br>12 mm |

## ECG Out Interface

### *ECG Out Cable*

| Product Option Number | Part Number<br>12NC Part No. | Description   | Conduit Sizes      | Bend Radius | Connector Size (Diameter) |
|-----------------------|------------------------------|---|--------------------|-------------|---------------------------|
| M8022A #A62           | 8120-1022<br>453563198151    | 3m cable (Both ends are terminated with .25" phone plugs)               | 40 mm <sup>2</sup> | 30 mm       | 13 mm                     |
|                       | M1181-61625<br>453563255091  | cable kit consisting of: 25 m raw cable, 2 x 1/4" socket, 1 x 1/4" plug |                    |             |                           |



---

# Gas Analyzers (not for MP5T)

For details on M1013AIntelliVue G1 and the M1019A IntelliVue G5, please refer to the respective Service Guide on your documentation CD.





# MP5 Product Structure

The following tables show the product option structure for the MP5.

| <b>Standard Base Unit M8105A</b>         |                                   |     |
|--|-----------------------------------|-----|
| <b>User Interface</b>                    |                                   |     |
| Touch                                    |                                   |     |
| Multiple Profiles and Screen Layouts     |                                   |     |
| Full Customization                       |                                   |     |
| <b>Patient Data Management</b>           |                                   |     |
| Standard Database Size for Trends        |                                   |     |
| Tabular and Graphical Trends             |                                   |     |
| Screen Trends                            |                                   |     |
| Record/Print ready Reports               |                                   |     |
| <b>Standard Applications</b>             |                                   |     |
| Basic Arrhythmia for stand-alone use     |                                   |     |
| ST Segment Analysis, Trends and Snippets |                                   |     |
| Networking Software                      |                                   |     |
| Event Surveillance - single Event Group  |                                   |     |
| <b>Standard Interfaces</b>               |                                   |     |
| ECG Sync Out                             |                                   |     |
| EASI derived 12-lead ECG                 |                                   |     |
| QT/QTc                                   |                                   |     |
| ST Map                                   |                                   |     |
| <b>Mandatory Options</b>                 |                                   |     |
| <b>Waves</b>                             |                                   |     |
|  | 3 Waves                           | A03 |
|  | 4 Waves                           | A04 |
| <b>Application Areas</b>                 |                                   |     |
|  | General / Intensive Care Software | H10 |
|  | Neonatal Software                 | H20 |
|  | Anesthesia Software               | H30 |
|  | Cardiac Care Software             | H40 |
| <b>Measurements</b>                      |                                   |     |
|  | SpO2, NBP                         | B10 |
|  | SpO2, NBP, P. Temp                | B11 |

|  |     |
|--|-----|
| SpO2, NBP, microstream CO2                     | B14 |
| ECG, Resp, NBP, SpO2                           | B20 |
| ECG, Resp, NBP, SpO2, Pred. Temp               | B21 |
| ECG, Resp, NBP, SpO2, Press./Temp x 1          | B22 |
| ECG, Resp, NBP, SpO2 + microstream CO2         | B24 |
| ECG, Resp, NBP, SpO2 + TAAP + Pred. Temp       | B31 |
| ECG, Resp, NBP, SpO2 + TAAP + P/T              | B32 |
| ECG, Resp, NBP, SpO2, Press./Temp, Pred. Temp  | B41 |
| ECG, Resp, NBP, SpO2, Press./Temp x 2          | B42 |
| ECG, Resp, NBP, SpO2, Press./Temp, CO2 ready   | B43 |
| ECG, Resp, NBP, SpO2, P/T + microstream CO2    | B44 |
| ECG, Resp, NBP, SpO2, 2x P/T + microstream CO2 | B54 |
| <b>Interfaces</b>                              |     |
| LAN & Video output [discontinues in Q1/2009]   | J01 |
| LAN & Battery Operation                        | J02 |
| Advanced System Interface                      | J40 |
| <b>Add-On Options</b>                          |     |
| <b>Clinical Applications</b>                   |     |
| Full Arrhythmia Capability                     | C01 |
| Neonatal Event Review                          | C04 |
| Drug Calculator                                | C05 |
| Basic Event Surveillance                       | C06 |
| Time distribution bar graph (Histograms)       | C09 |
| 12-lead ECG application (conventional)         | C12 |
| ST-MAP   | C13 |
| Full Networking Software                       | C15 |
| <b>Protocol Watch</b>                          |     |
| Sepsis Screening                               | P01 |
| <b>XDS external display solution</b>           |     |
| 4-wave XDS connectivity                        | X04 |
| 6-wave XDS connectivity                        | X06 |
| XDS remote control                             | X20 |
| <b>Hardware Add-On</b>                         |     |
| Built-in recorder                              | E05 |
| Bed hanger mount                               | E21 |
| Quick release mount                            | E22 |
| 1 X Lithium-Ion battery                        | E24 |

| <b>Interfaces</b>                  |  |     |
|------------------------------------|--|-----|
|                                    | MSL Interface  | J21 |
|                                    | IntelliVue 802.11 bedside adapter                        | J35 |
|                                    | Instrument Telemetry 1.4GHz                              | J45 |
|                                    | Instrument Telemetry 2.4GHz                              | J47 |
|                                    | Short Range Radio  | J46 |
|                                    |  |     |
| <b>Sensors and disposables</b>     |  |     |
| <b>low cost bundles</b>            |  |     |
|                                    | 3 lead Accessories Bundle ICU-AAMI - Tyco low cost cable | G06 |
|                                    | 3 lead Accessories Bundle ICU-IEC - Tyco low cost cable  | G07 |
|                                    | 5 lead Accessories Bundle ICU-AAMI - Tyco low cost cable | G08 |
|                                    | 5 lead Accessories Bundle ICU-IEC - Tyco low cost cable  | G09 |
| <b>5-lead IntelliVue bundles</b>   |  |     |
|                                    | 5 lead Accessories Bundle ICU-AAMI                       | H06 |
|                                    | 5 lead Accessories Bundle ICU-IEC                        | H07 |
|                                    | 5 lead Accessories Bundle OR-AAMI                        | H08 |
|                                    | 5 lead Accessories Bundle OR-IEC                         | H09 |
| <b>Neonatal IntelliVue bundles</b> |  |     |
|                                    | Accessories Bundle Neonatal –AAMI                        | H14 |
|                                    | Accessories Bundle Neonatal –IEC                         | H15 |
| <b>3-lead IntelliVue bundles</b>   |  |     |
|                                    | 3 lead Accessories Bundle ICU-AAMI                       | H16 |
|                                    | 3 lead Accessories Bundle ICU-IEC                        | H17 |
|                                    | 3 lead Accessories Bundle OR-AAMI                        | H18 |
|                                    | 3 lead Accessories Bundle OR-IEC                         | H19 |
|                                    | H20 Near Patient Application                             | H20 |
| <b>Mainstream CO2 accessories</b>  |  |     |
|                                    | CO2 Mainstream Sensor                                    | N01 |
|                                    | Reusable Adult Airway Adaptor (msCO2)                    | N02 |
|                                    | Reusable Infant Airway Adaptor (msCO2)                   | N03 |
|                                    | Single use Adult Airway Adaptor (msCO2)                  | N04 |
|                                    | Single use Infant Airway Adaptor (msCO2)                 | N05 |

| <b>Sidestream CO2 accessories</b>      |  |     |
|--|--|-----|
| CO2 Sidestream Sensor                  |  | N11 |
| Non-intubated adult (ssCO2)            |  | N12 |
| Non-intubated pediatric (ssCO2)        |  | N13 |
| Intubated adult (ssCO2)                |  | N14 |
| Intubated infant (ssCO2)               |  | N15 |
| <b>Microstream CO2 accessories</b>     |  |     |
| Non-Intubated Adult                    |  | K30 |
| Non-Intubated Pediatric                |  | K31 |
| Intubated Adult                        |  | K32 |
| Intubated Infant/Neonatal              |  | K33 |
| Adult Non-Invas. Ventilat.             |  | K34 |
| Pedia. Non-Invas.Ventilat.             |  | K35 |
| <b>Suretemp accessories</b>            |  |     |
| Pred. Temp Oral with 25 probe covers   |  | T01 |
| Pred. Temp Rectal with 25 probe covers |  | T02 |

The following tables show the product option structure for the MP5T.

| <b>Standard Base Unit M8105AT</b>        |  |  |
|--|--|--|
| <b>User Interface</b>                    |  |  |
| 3 wave, General ICU application, Touch   |  |  |
| <b>Patient Data Management</b>           |  |  |
| Standard Database Size for Trends        |  |  |
| Tabular and Graphical Trends             |  |  |
| Screen Trends                            |  |  |
| <b>Standard Applications</b>             |  |  |
| ST Segment Analysis, Trends and Snippets |  |  |
| EASI derived 12-lead ECG                 |  |  |
| QT/QTc                                   |  |  |

| <b>Mandatory Options</b>          |  |     |
|-----------------------------------|--|-----|
| <b>Waves</b>                      |  |     |
| 3 Waves                           |  | A03 |
| <b>Application Areas</b>          |  |     |
| General / Intensive Care Software |  | H10 |

| <b>Measurements</b>                |  |     |
|------------------------------------|--|-----|
|                                    | NBP, TAAP                              | B02 |
|                                    | NBP, SpO2, TAAP                        | B10 |
|                                    | NBP, SpO2, Pred. Temp., TAAP           | B11 |
| <b>Interfaces</b>                  |  |     |
|                                    | Short Range Radio                      | J46 |
| <b>Add-On Options</b>              |  |     |
| <b>Clinical Applications</b>       |  |     |
|                                    | Full Arrhythmia Capability             | C01 |
|                                    | Drug Calculator                        | C05 |
|                                    | ST-MAP                                 | C13 |
| <b>Hardware Add-Ons</b>            |  |     |
|                                    | Built-in recorder                      | E05 |
|                                    | Bed hanger mount                       | E21 |
|                                    | Quick release mount                    | E22 |
|                                    | 1 X Lithium-Ion battery                | E24 |
| <b>Microstream CO2 accessories</b> |  |     |
|                                    | Non-Intubated Adult                    | K30 |
|                                    | Non-Intubated Pediatric                | K31 |
|                                    | Intubated Adult                        | K32 |
|                                    | Intubated Infant/Neonatal              | K33 |
|                                    | Adult Non-Invas. Ventilat.             | K34 |
|                                    | Pedia. Non-Invas.Ventilat.             | K35 |
| <b>Sensors and disposables</b>     |  |     |
| <b>Suretemp accessories</b>        |  |     |
|                                    | Pred. Temp Oral with 25 probe covers   | T01 |
|                                    | Pred. Temp Rectal with 25 probe covers | T02 |



# Upgrades

The following table shows the upgrade options for the MP5.

| Upgrade M8105AU  |     |
|--|-----|
| <b>Mandatory Options</b>                                     |     |
| <b>Waves</b>   |     |
| 4 Waves  | A04 |
| <b>Parameter Add-ons</b>                                     |     |
| Adds Pred. Temp to B20 (ECG, NBP, SpO2)                      | B21 |
| Adds microstream CO2 to B20                                  | B24 |
| Adds Pred. Temp to B22 (ECG, NBP, SpO2, Press./Temp)         | B41 |
| Adds Press./Temp to B22 (ECG, NBP, SpO2, Press./Temp)        | B42 |
| Adds CO2 ready to B22 (ECG, NBP, SpO2, Press./Temp)          | B43 |
| Adds microstream CO2 to B22 (ECG, NBP, SpO2, Press./Temp)    | B44 |
| Adds microstream CO2 to B42 (ECG, NBP, SpO2, 2x Press./Temp) | B54 |
| <b>Interfaces</b>  |     |
| MSL Interface  | J21 |
| IntelliVue 802.11 bedside adapter                            | J35 |
| Advanced System Interface                                    | J40 |
| Instrument Telemetry 1.4GHz                                  | J45 |
| Instrument Telemetry 2.4GHz                                  | J47 |
| Short Range Radio  | J46 |
| <b>Add-On Options</b>  |     |
| <b>Clinical Applications</b>                                 |     |
| Full Arrhythmia Capability                                   | C01 |
| Neonatal Event Review  | C04 |
| Drug Calculator  | C05 |
| Basic Event Surveillance                                     | C06 |
| Time distribution bar graph (Histograms)                     | C09 |
| Conventional 12 lead ECG                                     | C12 |
| ST-MAP   | C13 |
| Full Networking Software                                     | C15 |
| Latest IntelliVue SW   | SUO |

| <b>Hardware Add-On</b>               |                           |     |
|--------------------------------------|---------------------------|-----|
|                                      | Built-in recorder         | E05 |
|                                      | Bed hanger mount          | E21 |
| <b>Protocol Watch</b>                |                           |     |
|                                      | Sepsis Screening          | P01 |
|                                      | Rev SW + Sepsis Screening | P41 |
| <b>XDS external display solution</b> |                           |     |
|                                      | 4-wave XDS connectivity   | X04 |
|                                      | 6-wave XDS connectivity   | X06 |
|                                      | XDS remote control        | X20 |

# Default Settings Appendix

This appendix documents the country-specific default settings of your monitor as it is delivered from the factory. For a comprehensive list and explanation of default settings, see the Configuration Guide supplied with your monitor. The monitor's default settings can be permanently changed in Configuration Mode.

Note: If your monitor has been ordered preconfigured to your requirements, the settings at delivery will be different from those listed here.

## Country-Specific Default Settings

Certain default settings are specific to a particular country. These are listed here for all countries alphabetically.

| Country-Description | Line Frequency | Units Weight | Units Height | ECG Cable Color |
|---------------------|----------------|--------------|--------------|-----------------|
|                     | 50/60 [Hz]     | kg, lb       | in, cm       | IEC, AAMI       |
| Afghanistan         | 50             | kg           | cm           | AAMI            |
| Åland Islands       | 50             | kg           | cm           | IEC             |
| Albania             | 50             | kg           | cm           | IEC             |
| Algeria             | 50             | kg           | cm           | IEC             |
| American Samoa      | 60             | lb           | in           | AAMI            |
| Andorra             | 60             | lb           | in           | AAMI            |
| Angola              | 50             | kg           | cm           | IEC             |
| Anguilla            | 60             | lb           | in           | AAMI            |
| Antarctica          | 60             | lb           | in           | AAMI            |
| Antigua and Barbuda | 50             | kg           | cm           | AAMI            |
| Argentina           | 50             | kg           | cm           | AAMI            |
| Armenia             | 50             | kg           | cm           | IEC             |
| Aruba               | 60             | kg           | cm           | AAMI            |

| Country-Description            | Line Frequency | Units Weight | Units Height | ECG Cable Color |
|--------------------------------|----------------|--------------|--------------|-----------------|
| Australia                      | 50             | kg           | cm           | AAMI            |
| Austria                        | 50             | kg           | cm           | IEC             |
| Azerbaijan                     | 50             | kg           | cm           | IEC             |
| Bahamas, The                   | 60             | kg           | cm           | AAMI            |
| Bahrain                        | 50             | kg           | cm           | AAMI            |
| Bangladesh                     | 60             | lb           | in           | AAMI            |
| Barbados                       | 50             | kg           | cm           | AAMI            |
| Belarus                        | 50             | kg           | cm           | IEC             |
| Belgium                        | 50             | kg           | cm           | IEC             |
| Belize                         | 60             | lb           | in           | AAMI            |
| Benin                          | 60             | lb           | in           | AAMI            |
| Bermuda                        | 60             | kg           | cm           | AAMI            |
| Bhutan                         | 60             | lb           | in           | AAMI            |
| Bolivia                        | 50             | kg           | cm           | AAMI            |
| Bosnia and Herzegovina         | 50             | kg           | cm           | IEC             |
| Botswana                       | 50             | kg           | cm           | IEC             |
| Bouvet Island                  | 60             | lb           | in           | AAMI            |
| Brazil                         | 60             | kg           | cm           | AAMI            |
| British Indian Ocean Territory | 60             | lb           | in           | AAMI            |
| Brunei Darussalam              | 50             | kg           | cm           | AAMI            |
| Brunei                         | 50             | kg           | cm           | IEC             |
| Bulgaria                       | 50             | kg           | cm           | IEC             |
| Burkina Faso                   | 50             | kg           | cm           | IEC             |
| Burundi                        | 50             | kg           | cm           | IEC             |
| Cambodia                       | 50             | kg           | cm           | IEC             |
| Cameroon                       | 50             | kg           | cm           | IEC             |
| Canada                         | 60             | kg           | cm           | AAMI            |
| Cape Verde                     | 60             | lb           | in           | AAMI            |
| Cayman Islands                 | 60             | kg           | cm           | AAMI            |
| Central African Republic       | 50             | kg           | cm           | IEC             |
| Chad                           | 60             | lb           | in           | AAMI            |
| Chile                          | 50             | kg           | cm           | AAMI            |

| Country-Description               | Line Frequency | Units Weight | Units Height | ECG Cable Color |
|-----------------------------------|----------------|--------------|--------------|-----------------|
| China                             | 50             | kg           | cm           | IEC             |
| Christmas Islands                 | 60             | lb           | in           | AAMI            |
| Cocos Keeling Islands             | 60             | lb           | in           | AAMI            |
| Colombia                          | 60             | kg           | cm           | AAMI            |
| Comoros                           | 60             | lb           | in           | AAMI            |
| Congo                             | 50             | kg           | cm           | IEC             |
| Congo, Democratic Republic of the | 50             | kg           | cm           | IEC             |
| Cook Islands                      | 60             | lb           | in           | AAMI            |
| Costa Rica                        | 60             | kg           | cm           | AAMI            |
| Côte d'Ivoire                     | 50             | kg           | cm           | IEC             |
| Croatia                           | 50             | kg           | cm           | IEC             |
| Cuba                              | 60             | kg           | cm           | IEC             |
| Cyprus                            | 50             | kg           | cm           | IEC             |
| Czech Republic                    | 50             | kg           | cm           | IEC             |
| Denmark                           | 60             | lb           | in           | AAMI            |
| Djibouti                          | 50             | kg           | cm           | IEC             |
| Dominica                          | 50             | kg           | cm           | AAMI            |
| Dominican Republic                | 60             | kg           | cm           | AAMI            |
| Ecuador                           | 60             | kg           | cm           | AAMI            |
| Egypt                             | 50             | kg           | cm           | IEC             |
| El Salvador                       | 60             | kg           | cm           | AAMI            |
| Equatorial Guinea                 | 50             | kg           | cm           | IEC             |
| Eritrea                           | 50             | kg           | cm           | IEC             |
| Estonia                           | 50             | kg           | cm           | IEC             |
| Ethiopia                          | 50             | kg           | cm           | IEC             |
| Falkland Islands, Malvinas        | 60             | lb           | in           | AAMI            |
| Faroe Islands                     | 60             | lb           | in           | AAMI            |
| Fiji                              | 60             | lb           | in           | AAMI            |
| Finland                           | 50             | kg           | cm           | IEC             |
| France                            | 50             | kg           | cm           | IEC             |
| French Guiana                     | 50             | kg           | cm           | IEC             |
| French Polynesia                  | 60             | lb           | in           | AAMI            |

| Country-Description               | Line Frequency | Units Weight | Units Height | ECG Cable Color |
|-----------------------------------|----------------|--------------|--------------|-----------------|
| French Southern Territories       | 60             | lb           | in           | AAMI            |
| Gabon                             | 50             | kg           | cm           | IEC             |
| Gambia, The                       | 50             | kg           | cm           | IEC             |
| Georgia                           | 60             | lb           | in           | AAMI            |
| Germany                           | 50             | kg           | cm           | IEC             |
| Ghana                             | 50             | kg           | cm           | IEC             |
| Gibraltar                         | 60             | lb           | in           | AAMI            |
| Greece                            | 50             | kg           | cm           | IEC             |
| Greenland                         | 60             | lb           | in           | AAMI            |
| Grenada                           | 50             | kg           | cm           | AAMI            |
| Guadeloupe                        | 50             | kg           | cm           | IEC             |
| Guam                              | 60             | lb           | in           | AAMI            |
| Guatemala                         | 60             | kg           | cm           | AAMI            |
| Guernsey                          | 50             | kg           | cm           | IEC             |
| Guinea                            | 60             | lb           | in           | AAMI            |
| Guinea-Bissau                     | 60             | lb           | in           | AAMI            |
| Guyana                            | 60             | kg           | cm           | AAMI            |
| Haiti                             | 60             | kg           | cm           | AAMI            |
| Heard Island and McDonald Islands | 60             | lb           | in           | AAMI            |
| Holy See, Vatican City State      | 60             | lb           | in           | AAMI            |
| Honduras                          | 60             | kg           | cm           | AAMI            |
| Hong Kong                         | 50             | kg           | cm           | IEC             |
| Hungary                           | 50             | kg           | cm           | IEC             |
| Iceland                           | 50             | kg           | cm           | IEC             |
| India                             | 50             | kg           | cm           | IEC             |
| Indonesia                         | 50             | kg           | cm           | IEC             |
| Iran, Islamic Republic of         | 50             | kg           | cm           | AAMI            |
| Iraq                              | 50             | kg           | cm           | AAMI            |
| Ireland                           | 50             | kg           | cm           | IEC             |
| Isle of Man                       | 50             | kg           | cm           | IEC             |
| Israel                            | 50             | kg           | cm           | IEC             |
| Italy                             | 50             | kg           | cm           | IEC             |

| Country-Description                     | Line Frequency | Units Weight | Units Height | ECG Cable Color |
|---|----------------|--------------|--------------|-----------------|
| Jamaica                                 | 50             | kg           | cm           | AAMI            |
| Japan                                   | 60             | kg           | cm           | IEC             |
| Jersey                                  | 50             | kg           | cm           | IEC             |
| Jordan                                  | 50             | kg           | cm           | AAMI            |
| Kazakhstan                              | 50             | kg           | cm           | IEC             |
| Kenya                                   | 50             | kg           | cm           | IEC             |
| Kiribati                                | 60             | lb           | in           | AAMI            |
| Korea, Democratic People's Republic of  | 60             | lb           | in           | AAMI            |
| Korea, Republic of                      | 60             | kg           | cm           | AAMI            |
| Kuwait                                  | 50             | kg           | cm           | AAMI            |
| Kyrgyzstan                              | 60             | lb           | in           | AAMI            |
| Lao People's Democratic Republics       | 50             | kg           | cm           | IEC             |
| Latvia                                  | 50             | kg           | cm           | IEC             |
| Lebanon                                 | 50             | kg           | cm           | AAMI            |
| Lesotho                                 | 50             | kg           | cm           | IEC             |
| Liberia                                 | 50             | kg           | cm           | IEC             |
| Libyan Arab. Jamahiriya                 | 60             | lb           | in           | AAMI            |
| Liechtenstein                           | 60             | lb           | in           | AAMI            |
| Lithuania                               | 50             | kg           | cm           | IEC             |
| Luxembourg                              | 50             | kg           | cm           | IEC             |
| Macao                                   | 60             | lb           | in           | AAMI            |
| Macedonia, The former Yugoslav. Rep. of | 50             | kg           | cm           | IEC             |
| Madagascar                              | 50             | kg           | cm           | IEC             |
| Malawi                                  | 50             | kg           | cm           | IEC             |
| Malaysia                                | 50             | kg           | cm           | IEC             |
| Maldives                                | 60             | lb           | in           | AAMI            |
| Mali                                    | 50             | kg           | cm           | IEC             |
| Malta                                   | 50             | kg           | cm           | IEC             |
| Marshall Islands                        | 60             | lb           | in           | AAMI            |
| Martinique                              | 60             | kg           | cm           | IEC             |
| Mauritania                              | 50             | kg           | cm           | IEC             |
| Mauritius                               | 60             | lb           | in           | AAMI            |

| Country-Description        | Line Frequency | Units Weight | Units Height | ECG Cable Color |
|----------------------------|----------------|--------------|--------------|-----------------|
| Mayotte                    | 60             | lb           | in           | AAMI            |
| Mexico                     | 60             | kg           | cm           | AAMI            |
| Micronesia, Fed. States of | 60             | lb           | in           | AAMI            |
| Moldova, Republic of       | 60             | lb           | in           | AAMI            |
| Monaco                     | 60             | lb           | in           | AAMI            |
| Mongolia                   | 60             | lb           | in           | AAMI            |
| Montenegro                 | 50             | kg           | cm           | IEC             |
| Montserrat                 | 50             | kg           | cm           | AAMI            |
| Morocco                    | 50             | kg           | cm           | IEC             |
| Mozambique                 | 50             | kg           | cm           | IEC             |
| Myanmar                    | 60             | lb           | in           | AAMI            |
| Namibia                    | 50             | kg           | cm           | IEC             |
| Nauru                      | 60             | lb           | in           | AAMI            |
| Nepal                      | 60             | lb           | in           | AAMI            |
| Netherlands                | 50             | kg           | cm           | IEC             |
| Netherlands Antilles       | 50             | kg           | cm           | AAMI            |
| New Caledonia              | 60             | lb           | in           | AAMI            |
| New Zealand                | 50             | kg           | cm           | AAMI            |
| Nicaragua                  | 60             | kg           | in           | AAMI            |
| Niger                      | 50             | kg           | cm           | IEC             |
| Nigeria                    | 50             | kg           | cm           | IEC             |
| Niue                       | 60             | lb           | in           | AAMI            |
| Norfolk Islands            | 60             | lb           | in           | AAMI            |
| Northern Mariana Islands   | 60             | lb           | in           | AAMI            |
| Norway                     | 50             | kg           | cm           | IEC             |
| Oman                       | 50             | kg           | cm           | AAMI            |
| Pakistan                   | 50             | kg           | cm           | IEC             |
| Palau                      | 60             | lb           | in           | AAMI            |
| Palestinian Territory      | 50             | kg           | cm           | AAMI            |
| Panama                     | 60             | lb           | in           | AAMI            |
| Papua New Guinea           | 60             | lb           | in           | AAMI            |
| Paraguay                   | 50             | kg           | cm           | AAMI            |



| Country-Description                          | Line Frequency | Units Weight | Units Height | ECG Cable Color |
|--|----------------|--------------|--------------|-----------------|
| Peru   | 60             | kg           | cm           | AAMI            |
| Philippines                                  | 60             | kg           | cm           | AAMI            |
| Pitcairn                                     | 60             | lb           | in           | AAMI            |
| Poland                                       | 50             | kg           | cm           | IEC             |
| Portugal                                     | 50             | kg           | cm           | IEC             |
| Puerto Rico                                  | 60             | lb           | in           | AAMI            |
| Qatar  | 50             | kg           | cm           | AAMI            |
| Reunion                                      | 60             | lb           | in           | AAMI            |
| Romania                                      | 50             | kg           | cm           | IEC             |
| Russian Federation                           | 50             | kg           | cm           | IEC             |
| Rwanda                                       | 50             | kg           | cm           | IEC             |
| Saint Helena                                 | 60             | lb           | in           | AAMI            |
| Saint Kitts and Nevis                        | 60             | kg           | cm           | AAMI            |
| Saint Lucia                                  | 50             | kg           | cm           | AAMI            |
| Saint Pierre and Miquelon                    | 60             | lb           | in           | AAMI            |
| Saint Vincent and the Grenadines             | 50             | kg           | cm           | AAMI            |
| Samoa  | 60             | lb           | in           | AAMI            |
| San Marino                                   | 60             | lb           | in           | AAMI            |
| Sao Tome and Principe                        | 60             | lb           | in           | AAMI            |
| Saudi Arabia                                 | 50             | kg           | cm           | AAMI            |
| Senegal                                      | 50             | kg           | cm           | IEC             |
| Serbia                                       | 50             | kg           | cm           | IEC             |
| Serbia & Montenegro                          | 50             | kg           | cm           | IEC             |
| Seychelles                                   | 60             | lb           | in           | AAMI            |
| Sierra Leone                                 | 50             | kg           | cm           | IEC             |
| Singapore                                    | 50             | kg           | cm           | IEC             |
| Slovakia                                     | 50             | kg           | cm           | IEC             |
| Slovenia                                     | 50             | kg           | cm           | IEC             |
| Solomon Islands                              | 60             | lb           | in           | AAMI            |
| Somalia                                      | 50             | kg           | cm           | IEC             |
| South Africa                                 | 60             | lb           | in           | AAMI            |
| South Georgia and the South Sandwich Islands | 60             | lb           | in           | AAMI            |

| Country-Description                  | Line Frequency | Units Weight | Units Height | ECG Cable Color |
|--------------------------------------|----------------|--------------|--------------|-----------------|
| Spain                                | 50             | kg           | cm           | IEC             |
| Sri Lanka                            | 60             | lb           | in           | AAMI            |
| Sudan                                | 50             | kg           | cm           | IEC             |
| Suriname                             | 60             | kg           | cm           | AAMI            |
| Svalbard and Jan Mayen               | 60             | lb           | in           | AAMI            |
| Swaziland                            | 60             | lb           | in           | AAMI            |
| Sweden                               | 50             | kg           | cm           | IEC             |
| Switzerland                          | 50             | kg           | cm           | IEC             |
| Syrian Arab Rep                      | 50             | kg           | cm           | AAMI            |
| Taiwan, Province of China            | 60             | kg           | cm           | AAMI            |
| Tajikistan                           | 60             | lb           | in           | AAMI            |
| Tanzania, United Republic of         | 60             | lb           | in           | AAMI            |
| Thailand                             | 50             | kg           | cm           | AAMI            |
| Timor-Leste                          | 60             | lb           | in           | AAMI            |
| Togo                                 | 60             | lb           | in           | AAMI            |
| Tokelau                              | 60             | lb           | in           | AAMI            |
| Tonga                                | 60             | lb           | in           | AAMI            |
| Trinidad and Tobago                  | 60             | lb           | in           | AAMI            |
| Tunisia                              | 50             | kg           | cm           | IEC             |
| Turkey                               | 50             | kg           | cm           | IEC             |
| Turkmenistan                         | 60             | lb           | in           | AAMI            |
| Turks and Caicos Islands             | 60             | kg           | cm           | AAMI            |
| Tuvalu                               | 60             | lb           | in           | AAMI            |
| Uganda                               | 60             | lb           | in           | AAMI            |
| Ukraine                              | 60             | lb           | in           | AAMI            |
| UK                                   | 50             | kg           | cm           | IEC             |
| United Arab Emirates                 | 50             | kg           | cm           | AAMI            |
| United Kingdom                       | 50             | kg           | cm           | OIEC            |
| United States                        | 60             | lb           | in           | AAMI            |
| United States (Weight kg)            | 60             | kg           | in           | AAMI            |
| United States (Height cm, Weight kg) | 60             | kg           | cm           | AAMI            |
| United States Minor Outlying Islands | 60             | lb           | in           | AAMI            |

| <b>Country-Description</b> | <b>Line Frequency</b> | <b>Units Weight</b> | <b>Units Height</b> | <b>ECG Cable Color</b> |
|----------------------------|-----------------------|---------------------|---------------------|------------------------|
| Uruguay                    | 50                    | kg                  | cm                  | AAMI                   |
| Uzbekistan                 | 60                    | lb                  | in                  | AAMI                   |
| Vanuatu                    | 60                    | lb                  | in                  | AAMI                   |
| Venezuela                  | 60                    | lb                  | in                  | AAMI                   |
| Viet Nam                   | 50                    | kg                  | cm                  | IEC                    |
| Virgin Islands (British)   | 50                    | kg                  | cm                  | AAMI                   |
| Virgin Islands (US)        | 60                    | lb                  | in                  | AAMI                   |
| Wallis and Futuna Islands  | 60                    | lb                  | in                  | AAMI                   |
| Western Sahara             | 50                    | kg                  | cm                  | IEC                    |
| Yemen                      | 50                    | kg                  | cm                  | AAMI                   |
| Zambia                     | 60                    | lb                  | in                  | AAMI                   |
| Zimbabwe                   | 60                    | lb                  | in                  | AAMI                   |



# Index

## 5

5/6 Lead vs. 12 Lead ECG Capability Identification • 214

## A

Abbreviations • 9

About the Battery • 107

adjustments • 10

After Each Service, Maintenance or Repair Event • 38

After Installation, Testing or Repair • 115

Alarm Behavior • 137

Alarm Lamps • 136

Alarm Tones • 137

Altitude • 253

analyzer,safety • 40

assembly • 10

## B

Barometric Pressure Check and Calibration • 93

Basic Nurse Call Relay (not for MP5T) • 123, 144

Basic Performance Assurance Test • 82

battery

    malfunction symbols • 108

    power gauge • 108

Battery Conditioning in the Monitor • 114

Battery Conditioning with an External Charger • 115

Battery Handling, Maintenance and Good Practices • 107

Battery related problems • 123, 130

Battery Status

    checking • 108

Battery Status on the Main Screen • 108

battery status recording • 111

battery status window • 110

Battery Status Window • 110

Bedside Network Status Icons (not for MP5T) • 123, 132



Before Each Use • 37, 38  
Block Diagram Legend • 24  
Boot Phase Failures • 124

## C

Cabling Options and Conduit Size Requirements • 257  
Calibration Verification • 95  
Carrying Out and Reporting Tests • 101  
Case 1  
    Medical Device Combined with Medical Device • 72  
Case 2  
    Medical Device Combined with a Non-Medical Device • 74  
Case 3  
    Medical Device Combined with a Medical or Non-Medical Device with one Device in a Non-Medically-Used Room • 78  
Check for Obvious Problems • 119  
Checking Country-Specific Default Settings • 222, 235  
Checking Out The Monitor • 222, 231  
Checking the Battery Status • 108  
checklist  
    delivery • 223  
    installation • 222  
Checks before opening the instrument • 120  
Checks Before Opening the Instrument • 120  
Checks for Obvious Problems • 119  
Checks with the Instrument switched Off • 120  
Checks with the Instrument switched On, AC connected, with battery • 120  
Checks with the Instrument switched On, AC connected, without battery • 120  
Checks with the Instrument switched On, AC not connected, with battery • 120  
Claims for Damage • 224  
Claims For Damage and Repackaging • 224  
cleaning  
    recommended substances • 150  
CO2 Gas Measurement Calibration Check • 94  
Compatibility with Information Center • 119  
Compatibilty of MP5 in Companion Mode with IntelliVue Patient Monitors • 118  
Compatible Devices • 19  
Conditioning a Battery • 111  
Conditioning Batteries • 113, 114  
configuration mode  
    entering • 235  
Configuration Settings for CSCN Routed Bedside Monitors (RBM) • 237  
Configuration Tasks • 234  
Configuring IP Address, Subnet Mask and Default Gateway • 236

- Configuring Routed Bedside Monitors Support • 237
- Configuring SRR Channels • 243
- Configuring the Equipment Label • 236
- Connecting Non-Medical Devices • 255
  - connecting power • 231
- Connecting the Monitor to AC Mains • 231
- Connecting the MP5 to a Host Monitor (not for MP5T) • 246
- Connection of Devices via the MIB/RS232 Interface • 233, 240
- Connections • 232, 239, 247
- Country-Specific Default Settings • 279

## D

- Data Acquisition • 19
- Data Flow • 19
- Data Provider System Service • 20
- date, setting • 238
- default settings • 279
- Default Settings Appendix • 279
- Disabling/Enabling Touch Operation • 106
- Disassembling the Predictive Temperature Assembly • 154
- Display and User Interface Service • 20
- Documenting Battery Status • 111

## E

- ECG Out Functionality (ECG Sync) (not for MP5T) • 247
- ECG Out Interface • 260
- ECG Performance • 83
- ECG Sync Performance Test • 84
- ECG Sync Pulse (not for MP5T) • 233, 248
- ECG/Resp
  - Performance check • 83
- ECG/Resp Performance Test • 83
- Electrical and Safety Requirements • 256, 257
- Electrical and Safety Requirements (Customer or Philips) • 253
- Electrical Requirements • 254
- Electromagnetic Emissions • 221
- Electromagnetic Interference (SRR) • 222
- enclosure leakage current test • 64, 65
- Environmental Requirements • 252, 256, 257
- Evaluation • 104
- Evaluation of Test Results • 37, 104
- Exchange and Replacement Parts • 206
- Exchanging the Backlight • 199
- extensions • 10

External Display is blank (Slave Display) • 127  
External Display Part Numbers (not for MP5T) • 203, 217

## F

Flow Rate Check and Calibration • 93  
Full Performance Assurance Test • 83

## G

Gas Analyzers (not for MP5T) • 261  
General Monitor INOP Messages • 128  
General Requirements for a System • 68  
Guideline for Performance of Safety Tests • 43

## H

Handing Over the Monitor • 238  
Hardware Building Blocks • 16  
Hardware Settings • 240  
Hints for Correct Performance of Safety Tests • 42  
How does the Support Tool Work with the Monitor • 22  
How to use the Troubleshooting tables • 123  
How to Use This Guide • 9  
How To Use This Section • 117  
Humidity • 253

## I

IIT Communication Test • 99  
IIT-related Problems (not for MP5T) • 123, 134  
Image Sticking • 145  
Individual Parameter INOPs • 138  
Initial Inspection • 223  
Initial Instrument Boot Phase • 121  
installation • 10, 219  
    checklist • 222  
    personnel • 219  
Installation Checklist • 222  
Installation Instructions • 219  
Installing Remote Devices (not for MP5T) • 238  
Installing the Predictive Temperature Probe • 224  
Integrated Display is blank • 125  
IntelliVue 802.11 Bedside Adapter Communication Test • 98  
IntelliVue 802.11 Bedside Adapter Problems (not for MP5T) • 123, 134  
IntelliVue Instrument Telemetry (IIT)(not for MP5T) • 242  
IntelliVue MP5/MP5T • 17  
Internal LAN (Measurement Link) • 21



Introduction • 9, 31, 117, 249  
Invasive Pressure Performance Test • 87  
Isolating problems to the correct subassembly • 117, 149

## L

Leakage Check • 92  
List of Error Codes • 146  
loading paper • 234  
Loading Paper • 222, 234

## M

mains power  
    connecting to • 231  
Mainstream CO2 Accuracy Check • 88  
malfunction symbols  
    battery • 108  
Measurement Validation • 85  
MIB / RS232 (not for MP5T) • 123, 142  
Microstream CO2 Performance Test • 91  
modifications • 10  
Modified MP5 Nurse Call Alarm Relay Test • 97, 202  
Modifying the Nurse Call Relay • 201  
Monitor Applications • 21  
monitor defaults • 279  
Monitor Site Requirements • 252  
Monitor Software Block Diagram • 23  
Monitor Theory of Operation • 13  
mounting information • 225  
Mounting the 15 • 238  
Mounting the 17 • 239  
Mounting the Monitor • 222, 225  
Mounting the Monitor on the Wall Mount using the Mounting Plate • 230  
Mounting the Monitor on the Wall Mount using the Quick Mount • 228  
Mounting the Monitor onto the Rollerstand using the Mounting Plate • 229  
Mounting the Monitor onto the Rollstand using the Quick Mount • 228  
Mounting the Monitor using the Mounting Plate (Fix Mount) • 228  
Mounting the Monitor using the Quick Mount • 227  
MP5 Product Structure • 263  
MP5 with Rev. E • 214  
MP5 with Rev. F and higher • 215  
MP5/MP5T Parts • 203, 204  
MSL-related problems (not for MP5T) • 123, 128

## N

- NBP Accuracy Test • 85
- NBP Leakage Test • 86
- NBP Linearity Test • 87
- NBP Performance Test • 85
- Network related problems (not for MP5T) • 123, 132
- Noise Check • 94
- Noninvasive Blood Pressure Measurement Calibration • 82
- Nurse Call Relay (not for MP5T) • 247
- Nurse Call Relay Interface • 259
- Nurse Call Relay Performance Test • 96

## O

- Obtaining Replacement Parts • 119
- Optional Hardware • 17
- Other Regular Tests • 105
- Out-Of-Hospital Transport - Standards Compliance • 220

## P

- paper
  - loading • 234
- Parts • 203
- parts and accessories • 10
- Passwords • 10
- PCB
  - replacement level support • 118
- performance • 10
- Performance Assurance Tests • 37, 82
- Persistent Data Storage System Service • 20
- Philips Clinical Network • 22
- Philips Clinical Network (Wired) (not for MP5T) • 240
- Philips Clinical Network (Wireless) (not for MP5T) • 241
- Philips IntelliVue Information Center • 241
- Philips Medical LAN • 258
- Phone Jack Type Connector Test (Traditional Nurse Call) • 96
- power
  - connecting • 231
  - connection • 231
- Power Distribution • 17
- Power Loss Alarm Buzzer Performance Test (only if Multi-Port Nurse Call Connector Board is installed) • 98
- Power Loss Alarm Buzzer Problems • 123, 137
- Power On Test • 38
- Predictive Temperature Problems • 123, 138

- Preventive Maintenance Procedures • 82
- Printer (not for MP5T) • 123, 141
- Printer Test Report • 106
- Procedures for Local Staff • 250
- Procedures for Philips Personnel • 252
- Pump Check • 93

## R

- Recommended Frequency • 32
- Recorder • 123, 142
- recording
  - battery status • 111
- reliability • 10
- Remote Device Site Requirements • 254
- Remote Displays - M8031B • 255
- Remote Displays - M8033C • 256
- Removing the Backlight Inverter Board • 172
- Removing the Handle or Bedhanger • 150
- Removing the IntelliVue 802.11 Bedside Adapter (WLAN) (not for MP5T) • 164
- Removing the IntelliVue 802.11 Bedside Adapter Antenna or IIT Antenna (not for MP5T) • 164
- Removing the IntelliVue 802.11 Bedside Adapter/IIT Holder (not for MP5T) • 169
- Removing the IntelliVue Instrument Telemetry (IIT) Module (not for MP5T) • 167
- Removing the Internal Quick Mount Solution • 161
- Removing the LCD Panel • 198
- Removing the Loudspeaker • 195
- Removing the Main Board • 191
- Removing the Measurement Block • 184
- Removing the Microstream CO2 Assembly • 178
- Removing the MSL Board (not for MP5T) • 170
- Removing the NBP Pump • 188
- Removing the Power Button and LED Assembly • 196
- Removing the Power Supply • 173
- Removing the Predictive Temperature Assembly • 151
- Removing the Recorder Board • 176
- Removing the Recorder Slot Cover • 160
- Removing the Short Range Radio (SRR) Interface • 161
- Removing the System Interface Board • 175
- Removing the Touch Assembly • 194
- Repackaging for Shipment or Storage • 224
- Repair and Disassembly • 149
- repairs • 10
  - qualified personnel • 117
- Replacement level

major subassembly • 118  
PCB • 118  
Replacement Level Supported • 118  
Replacement parts. See Spare parts • 119  
Reporting of Test Results • 37, 101  
Required Protective Measures at System Installation • 71  
Reset Time Counters • 96  
Respiration Performance • 83  
Responsibility of the Manufacturer • 10  
Roles & Responsibilities • 250  
RS232/MIB Interface • 258

**S**

S(1)  
Protective Earth Resistance Test • 63

S(2)  
Equipment Leakage Current Test - Normal Condition • 64

S(3)  
Equipment Leakage Current Test - Single Fault Condition • 65

S(4)  
Applied Part Leakage Current - Mains on Applied Part • 66

safety • 10  
tests • 39

Safety Requirements • 253  
Safety Test Adapter Cable - Schematics • 45  
Safety Test Procedures • 37, 41  
safety tests • 39  
performance tests • 231  
power on test • 231  
system • 231  
visual inspection • 231

Safety Tests • 39  
Separating the Front and Back of the Monitor • 155  
Setting Altitude, Line Frequency, ECG Cable Colors and Height & Weight Units • 235  
Setting the Date and Time • 222, 238  
settings  
default • 279

Short Range Radio • 243  
Short Range Radio (SRR) Performance Test • 100  
Short Range Radio Interface Problems • 123, 135  
Sidestream CO2 Accuracy Check • 89  
Sidestream CO2 Flow Check • 90  
Site Planning • 249

- Site Preparation • 249
- Site Preparation Responsibilities • 250
- Software Revision Check • 118
- Space Requirements • 252, 255, 256
- Spare parts
  - obtaining • 118
- SpO2 Performance Test • 84
- SRR Channel Settings Configuration Implications • 244
- Status Log • 145
- symbols
  - battery • 108
- system
  - medical electrical • 68
- System Boundaries • 14
- System Example • 69
- System Installation Requirements • 70
- System Interfaces • 18
- System Test • 39, 68
- System Test Procedure • 81

## T

- Telemetry Device (Patient Worn Device) cables • 259
- Telemetry Device related Problems (TAAP) • 123, 140
- Temperature • 253
- Temperature Performance Test • 88
- Terminology and Definitions • 32
- Test and Inspection Matrix • 102
- test blocks, how to perform • 231
- Test Report • 101
- Testing and Maintenance • 31
- Testing Sequence • 37
- tests
  - enclosure leakage current • 64, 65
  - safety • 39
- Theory of Operation • 13
- time, setting • 238
- Tools required • 150
- Touch Cable • 258
- Touch Operation not functioning • 126
- Touchscreen Calibration • 105
- Troubleshooting • 117
- Troubleshooting Guide • 119
- Troubleshooting Tables • 122



Troubleshooting the ECG OUT (not for MP5T) • 123, 144  
Troubleshooting the ECG Sync Pulse (not for MP5T) • 123, 144  
Troubleshooting the Individual Measurements or Applications • 147  
Troubleshooting with the Support Tool • 147

## U

unpacking • 223  
Unpacking and Checking the Shipment • 222, 223  
Upgrades • 276

## V

Valve Test • 87  
Verification Procedure • 202  
Video Cable Wiring Schematics • 240  
Viewing Battery Details • 111  
Visual Inspection • 38  
voltage setting • 231

## W

Warnings and Cautions • 11  
Warnings, Cautions, and Safety Precautions • 40  
What Causes the Conditioning Message on the Monitor? • 113  
What is a Medical Electrical System? • 68  
What is Battery Conditioning? • 111  
When Should Battery Conditioning be Performed? • 112  
When to Perform Tests • 33, 82  
Who Should Perform Repairs • 117, 149  
Who Should Use This Guide • 9  
Why is Battery Conditioning Necessary? • 112  
window  
    battery status • 110